



- **Dedicated for ramp/soak profile applications**
 - easy to use and follow customized display with direct control of the profile
- **Simple selection of multi-segment profiles**
 - 99 segments and 20 profiles, configurable via the PC Configurator or front facia
- **Clear multicolor display with fingertip adjustment**
 - displays current program/segment, set point, time remaining and profile status
- **Automatic operation with manual override**
 - dedicated switches to Run/Hold or Stop and selection of profiles
- **Comprehensive input/output capabilities**
 - three analog inputs, two analog outputs, up to four relays and four digital inputs, plus RS485 Modbus for total flexibility
- **Guaranteed ramp/soak with individual hysteresis**
 - ensuring product quality, whatever the process conditions
- **Self-seeking set point function**
 - save process startup time, reduce costs
- **Easy-clean NEMA4X/IP66 front face**
 - ideal for hosedown and harsh applications



C360 – a comprehensive profile controller for all ramp/soak applications



C360

The C360 Profile Controller has advanced ramp/soak profiling to make the operation as simple and as easy as possible for the operator. A dedicated display shows, at a glance, set point, process variable, current program/segment and time remaining in that segment. Three LEDs indicate the direction of the segment, either ramping up/down or in a soak, while the profile is running.

To give a simplified operator interface, specialized buttons have been included to Run/Hold or Stop the profile and to increase or decrease the time remaining in the current segment.

Special features include guaranteed ramp/soak, self-seeking set point, four time events (which can be allocated to relays as common events), maths, alarm and interlocking logic as well as cascade control for complex applications.

WThe C360 has a NEMA4X/IP66 front face making it ideal for use in the harshest of environments.

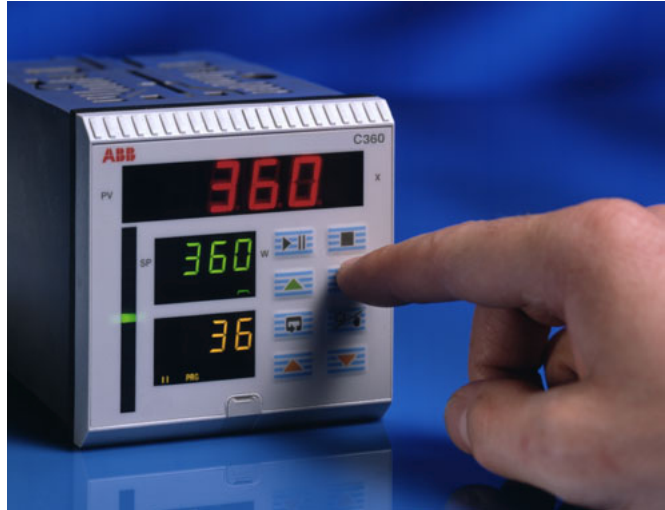

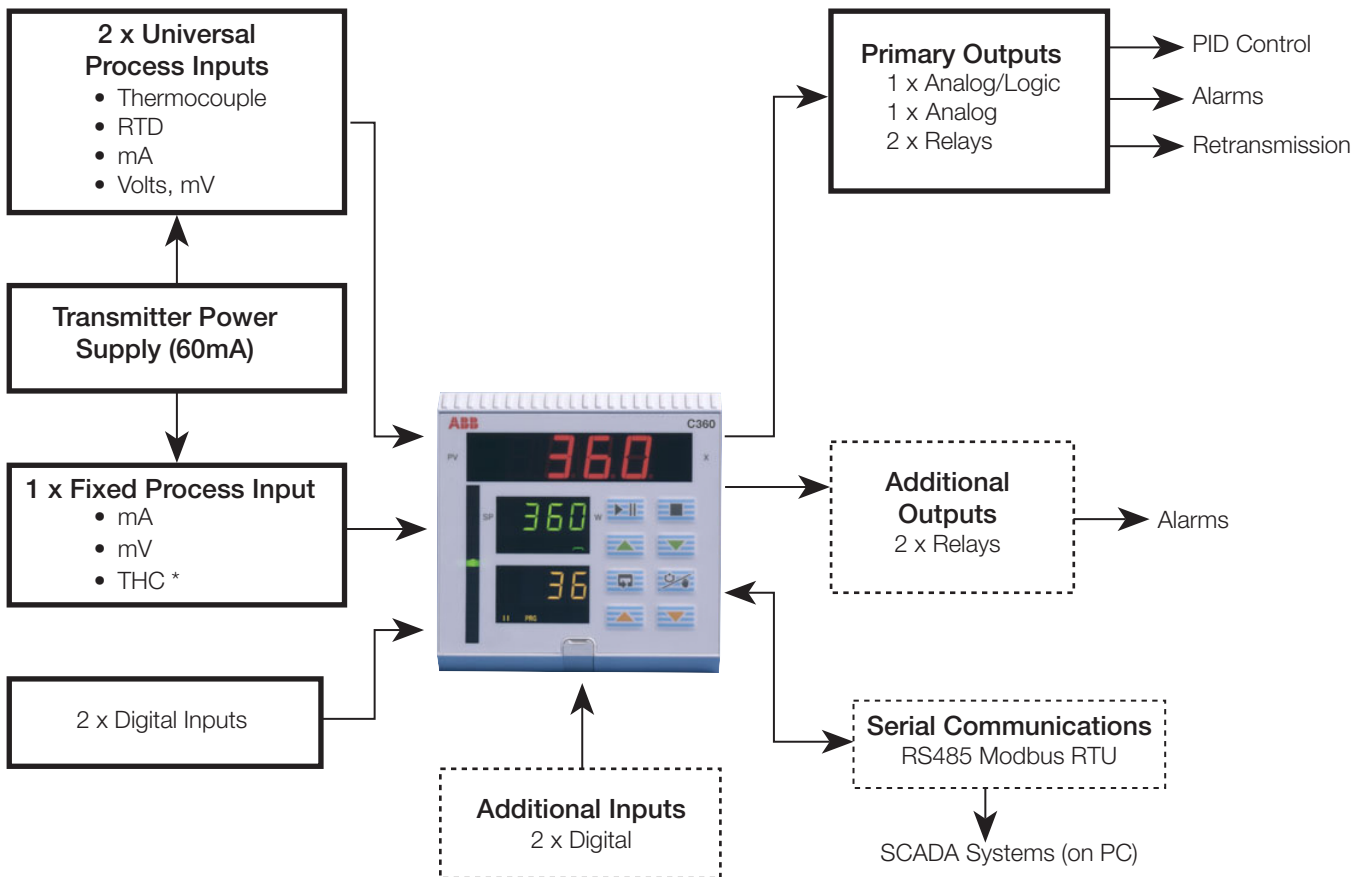

Process Connections



KEY: Standard Option * Only if universal input 1 is THC

Dedicated Ramp/Soak Display

Status LEDs give a clear indication of the profile progress, showing whether a ramp or soak is being performed. A dedicated display indicates the segment which is currently running and time remaining, together with the standard controller display, which shows the current set point and actual process value.

The profile can be Run/Hold  or Stopped  via the dedicated switches on the front face, by external digital inputs or Modbus.

Guaranteed Ramp/Soak

This feature has been designed to make operation as flexible as possible. There are two hysteresis settings; one applicable to soak segments, the other to ramp segments.

The guaranteed hysteresis value can be applied to individual segments above set point, below set point, both or none. This gives the user the option to HOLD a cycle, only if it falls outside a preset value, e.g. where regulations state a minimum (but no maximum) temperature or where the ramping segment is allowed to reach temperature as quickly as possible, so saving process time and money.

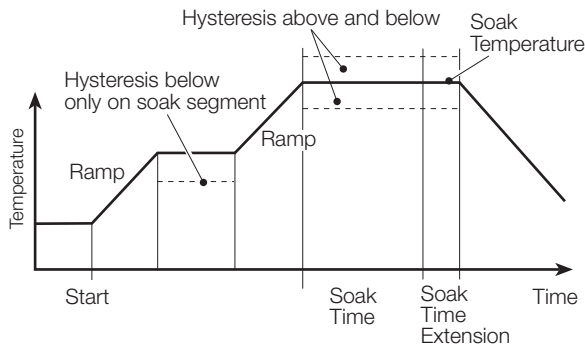

Programmable Power Failure Recovery

The power failure recovery function allows pre-selection of the restart position within the profile. If power is restored within the programmable power down time, the C360 resumes from the point in the profile that the power failed. If, however, the power down time has expired, the C360 holds the program and can restart in three different ways:

- a) the current program from the beginning;
- b) the current segment;
- c) the current segment from the position at the time of failure.

Alternatively, Real-time recovery can be used in which C360 resumes from the point in the profile that would have been reached had the power failure not occurred.

Configuration and Startup Made Easy

The C360 is available with two standard templates, single loop or cascade. Once you select the one that suits your application only the settings for that application are shown, making configuration and startup quick and easy.

Complete configurations can be created, edited and stored off-line, using the PC Configurator. A dedicated cable connects the PC to a jack socket on the top of the controller for rapid upload, or download, of configurations. Copies of the configurations can be saved digitally and produced as hard copy.

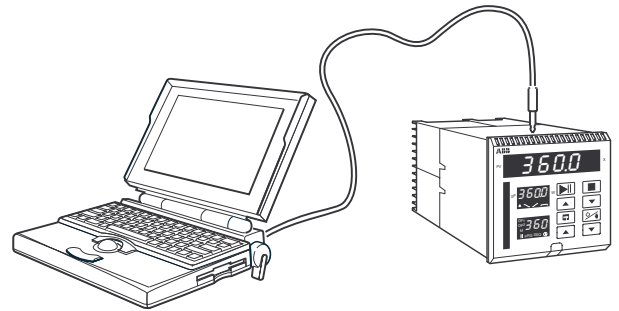

Event States

The C360 has four time events which can be allocated to relay or digital outputs and each segment can be configured to initiate any event. This enables an event to be triggered from multiple segments, or for one segment to trigger multiple events, providing a flexible and powerful control strategy.

In addition, individual segment event states for the 99 segments and individual program event states for the 20 programs are available.

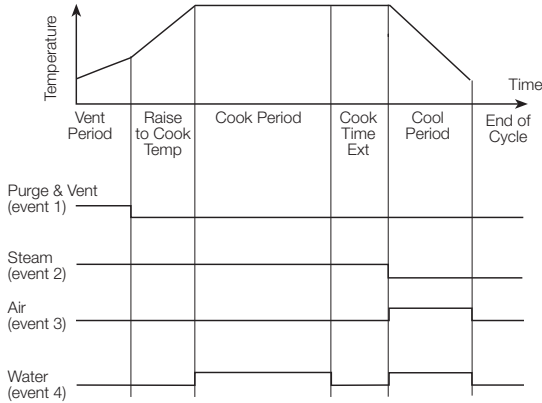

Self-seeking Set Point

To reduce process time, the C360 has a self-seeking set point setting which enables a profile to start from the current process temperature. This eliminates the wasted time normally taken to drive the process temperature down to the actual start temperature for the profile.

Ramp/Soak Profiles – Easy to Compile

Profiles can either be programmed via the front panel or the Windows-based PC configurator software. Time scales can be set in hours or minutes and ramp segments can be configured using segment time (hrs/min) or ramp rate (°F or °C, min or hrs).

The C360 can store up to 20 programs as standard. However, using the PC configurator, you can store multiple configurations each containing different profiles. Downloading to the C360 takes seconds, reducing the time that the process is off line.

Sequencing and Logic Control

The C360 offers comprehensive sequencing to complement its advanced analog control features with six logic equations and up to fifteen elements per equation. These six logic equations, when combined with delay timers, real-time alarms, program and segment events make the C360 a powerful sequence controller.

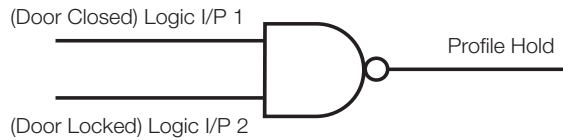

For safety purposes, logic equations can be included as part of the profile control, disabling the ability to run unless all safety interlocks are in place.

Process Alarms

The C360 has eight internal process alarms. These can be soft-wired to control strategies, logic equations and output relays.

Each alarm can have a separate hysteresis value, programmable in engineering units and/or time. Alarms can also be enabled or disabled via digital inputs.

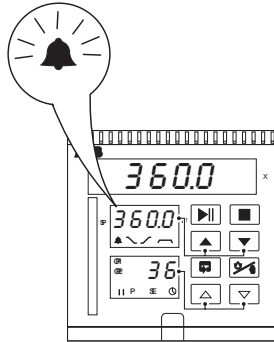

Maths and Soft-Wiring

Four individual math blocks, each having up to 7 operators and operands, provide functions such as average, maximum and minimum calculations. Square root, relative humidity and arithmetic functions are also included as standard. Inputs can be selected or switched in and out of calculations by digital signals. This allows both simple and advanced calculations to be processed and these can be soft-wired to control functions, such as Sequencing and Logic Control.

Product/Profile Selection

Recipes can be selected either via the front panel, multi-position selector switches connected to the C360's digital inputs or by a Modbus Master, allowing the selection of a profile for the product being processed in the most convenient format.

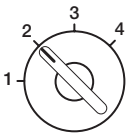

PROGRAM

(or RECIPE)

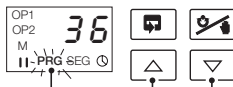

Providing simple, easy operator product selection

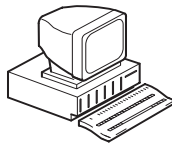

Modbus MASTER

Selectable Gain

To optimize your process control, and the response of the C360, four independent PI terms are available. This eliminates the need to manipulate variables as a result of process conditions and loads. These are selectable via internal process alarms or digital inputs, which may include a segment of a profile. This ensures tighter control and better response action at a specific set point.

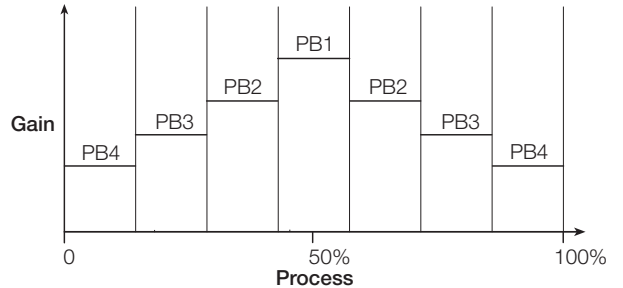

Custom Linearizer

The C360 has two separate 15-breakpoint linearizers which can be programmed via the PC Configurator and applied to either inputs or outputs. These can be used for nonstandard thermocouples, nonlinear tank levels or any nonlinear input. On outputs, the linearizer accommodates any nonlinear control elements, such as a butterfly valve.

Industrial Robust Design

The front face has been designed to meet IP66/NEMA4X rating, with a unique moulded case and panel seal. A chemically resistant polyester front panel provides a secure barrier in any environment.

Specification

Summary

Single-loop or Cascade
 Two Autotune options
 20 profiles, 99 segments
 PC configuration
 IP66/NEMA4X front face

Operation

Display

1 x 4-digit, 14mm (Red) LED, process variable
 1 x 4-digit, 8mm (Green) LED, set point
 1 x 3-digit, 8mm (Yellow) LED, output, program/segment, profile time remaining

Configuration

Basic configuration via front panel keys or PC
 Advanced feature configuration by PC

Security

Password-protected menus

Standard Functions

Control strategies

Single-loop or Cascade

Output types

Current Proportioning, Time Proportioning, On/off, Motorized Valve (with or without feedback), Heat/Cool

Control parameters

Four sets of PI settings, selectable via digital signals

Set points

99 segments, 20 profiles

Configured outputs

Three preset control output values, selectable via digital signals

Autotune

On demand for 1/4 wave or minimal overshoot

Process alarms

Number	8
Types	High/Low process High/Low output High/Low deviation High/Low inputs
Hysteresis	Level and time *
Alarm enable/disable *	Level and time *

Real time alarms *

Number	2
Programmable	On time/day and duration

* Accessed via PC Configurator

Analog Inputs

Universal Process Inputs

Number

2 standard

Type

Universally configurable to provide:
Thermocouple (THC)
Resistance thermometer (RTD)
mV
Volts
mA
Resistance

Non-universal Process Input

Number

1 standard

Type

mV only (THC only if I/P1 is also THC)
mA

Analog Inputs – Common

Linearizer Functions

THC types B, E, J, K, L, N, R, S, T, PT100, $\sqrt{\quad}$, $3/2$, $5/2$

Input Impedance

mA 100 Ω

mV, V 10M Ω

Broken Sensor Protection

Programmable for upscale or downscale drive

Sample Interval

125ms (1 input)

Digital filter

Programmable

Cold Junction Compensation

Automatic CJC incorporated as standard

Stability 0.05°C/°C (0.09°F/°F) change in ambient temperature

Input Protection

Common mode rejection >120dB at 50/60Hz with
300 Ω imbalance resistance

Series mode rejection >60dB at 50/60Hz

2-Wire Transmitter Power Supply

Voltage 24V DC nominal

Drive Up to 60mA as standard, (3 loops)

Isolation Share common analog 0V

...Specification

Standard Analog Input Ranges

Thermocouple	Maximum Range °C	Maximum Range °F	Accuracy (% of reading)
B	-18 to 1800	0 to 3270	0.1% or ±1°C (1.8°F) [above 200°C (392°F)] *
E	-100 to 900	-140 to 1650	0.1% or ±0.5°C (0.9°F)
J	-100 to 900	-140 to 1650	0.1% or ±0.5°C (0.9°F)
K	-100 to 1300	-140 to 2350	0.1% or ±0.5°C (0.9°F)
L	-100 to 900	-140 to 1650	0.1% or ±1.5°C (2.7°F)
N	-200 to 1300	-325 to 2350	0.1% or ±0.5°C (0.9°F)
R	-18 to 1700	0 to 3000	0.1% or ±0.5°C (0.9°F) [above 300°C (540°F)] *
S	-18 to 1700	0 to 3000	0.1% or ±0.5°C (0.9°F) [above 200°C(392°F)] *
T	-250 to 300	-400 to 550	0.1% or ±0.5°C (0.9°F)

* Performance accuracy is not guaranteed below 300°C (572°F) for B, R and S thermocouples

Min. span below zero Type T 70°C (126°F) Type N 105°C (189°F) THC standards DIN 43710 IEC 584

RTD	Maximum Range °C	Maximum Range °F	Accuracy (% of reading)**
PT100	-200 to 600	-325 to 1100	0.1% or ±0.5°C (0.9°F)

** RTD, 3-wire platinum, 100Ω per DIN43760 standard (IEC751), with range of 0 to 400Ωs

Linear Inputs	Range	Accuracy (% of reading)
Millivolts	0 to 500 mV	0.1% or ±10μA
Milliamperes	0 to 50 mA	0.2% or ±2μA
Volts	0 to 5V	0.2% or ±2mV
Resistance	0 to 5000Ω	0.2% or ±0.08Ω

EMC

Emissions

Meets requirements of EN50081-2

Immunity

Meets requirements of EN50082-2

Design & manufacturing standards

CSA/UL General Safety

Satisfies the requirements of –
CAN/CSA C22.2 No. 1010.1-1-92 Standard
CAN/CSA C22.2 No. 1010.1-B97
UL Standard 3121-1

FM General Safety Pending

Outputs

Control/Retransmission Outputs

Number	2 standard
Type	1 x Programmable as analog or logic (digital) output 1 x analog only
Isolation	Galvanically isolated from each other and the rest of the circuitry
Analog range	0 and 20mA (programmable), accuracy 0.25%
Digital voltage	17V @ 20mA

Relay outputs

Number	2 standard, 2 optional
Type	SPCO, rated 5A at 115/230V AC (non-inductive)

Digital Inputs

Number	2 standard, 2 optional
Type	Volt-free
Minimum pulse	200ms
Isolation	Share common digital 0V

Advanced Features

Maths Blocks *

Number	4
Operators	+, -, x, ÷, Average, Maximum, Minimum, High select, Low select, √, Median select, Relative Humidity Input multiplexer (digitally selected)

Delay Timers *

Number	2
Programmable Delay and Duration in seconds	

Logic Equations *

Number	6
Elements	15 per equation
Operators	OR, AND, NOR, NAND, NOT, EXOR

Custom Linearizers *

Number	2
Breakpoints	15 per linearizer

* Accessed via PC Configurator

Options

Relay Outputs

Number	2
Type	SPST, rated 5A at 115/230V AC normally open or normally closed

Digital Inputs

Number	2
Type	Volt-free
Minimum pulse	200ms

Serial Communications

Connections	RS485, 2- or 4-wire
Protocol	Modbus RTU
Isolation	Galvanically isolated from the rest of the circuitry

Physical

Size

96 x 96 x 122.5mm (3.78 x 3.78 x 4.82 in.)

Weight

680g (1.5 lb)

Electrical

Voltage

85V min. to 165V max. AC 50/60Hz

24V DC

Power consumption

15VA max.

Power interruption protection

Up to 60ms

Dielectric Strength

All inputs/outputs to earth: 500V DC

Analog/digital output 1 to rest of the circuitry:
500V DC for 1 minute

Analog output 2 to rest of the circuitry:
500V DC for 1 minute

Serial communications to rest of the circuitry:
500V DC for 1 minute

Environmental

Operating Limits

0 to 55°C (32 to 130°F)

5 to 95%RH (non-condensing)

Temperature stability

<0.02%/°C or 2μV/°C (<0.011%/°F or 1.11μV/°F)

Long term drift <0.02% of reading or 20μV annually

Front face

NEMA4X (IP66)

Overall Dimensions

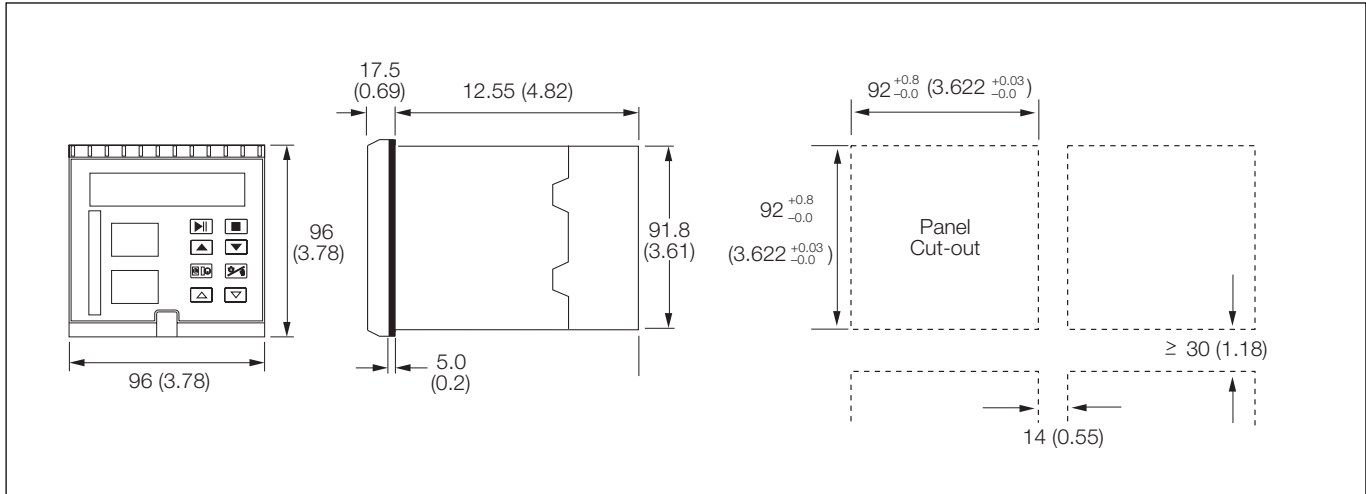

Electrical Connections

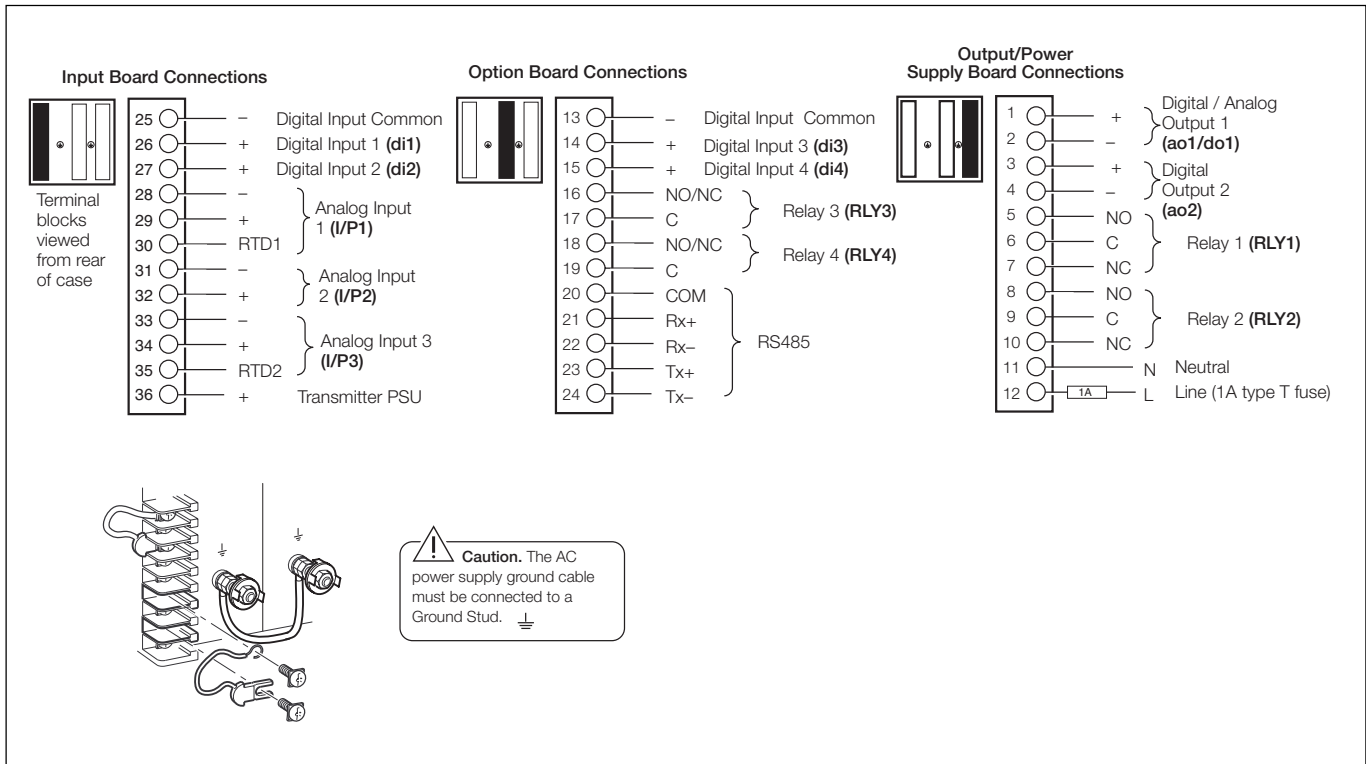

Ordering Information

C360 1/4 DIN Multi-Recipe Profile Controller	C360 /	X X	X	X /	X X X X
Option Board					
None		0 0			
2 digital inputs + 2 relays		0 1			
2 digital inputs + 2 relays + RS485 Modbus		0 2			
Power Supply					
85V min. to 265V max. AC			0		
24V DC			1		
Build					
ABB Standard				0	
CSA/UL approval (cCSAus mark)				1	
Programming/Special Features					
Configured to factory standard					S T D
Configured to customer requirements					C U S
Special features					S P X X

Accessories

PC Configurator Kit (part no.C100/0700)

Licensing, Trademarks and Copyrights

Modbus™ is a trademark of Modicon, Inc.

Windows™ is a trademark of the Microsoft Corp.

ABB has Sales & Customer Support
expertise in over 100 countries worldwide

www.abb.com

The Company's policy is one of continuous product
improvement and the right is reserved to modify the
information contained herein without notice.

Printed in UK (01.03)

© ABB 2003



ABB Limited
Howard Road, St Neots
Cambridgeshire
PE19 8EU
UK
Tel: +44 (0)1480 475321
Fax: +44 (0)1480 217948

ABB Inc.
125 E. County Line Road
Warminster
PA 18974
USA
Tel: +1 215 674 6000
Fax: +1 215 674 7183