

- **Large clear display**
 - 31cm (12.1 in.) thin film transistor (TFT) color screen
- **Unsurpassed environmental protection**
 - hosedown to IP66 and NEMA4X standards
- **Multiple point recording**
 - up to 36 universal analog inputs
- **Robust and convenient archive storage**
 - solid-state high-reliability SmartMedia and Compact Flash memory card options
- **Intuitive user interface**
 - clear and simple Windows-style operation and configuration menus
- **10BaseT Ethernet communications as standard**
 - easy integration into PC networks
 - remote monitoring/access
 - email notification of alarms and status reports
- **21 CFR Part 11 compliant data security**
 - extensive physical and electronic security features



**Raising the Standards
of Data Storage**

SM3000

The SM3000 Multipoint Videographic Recorder features state-of-the-art data storage and security technologies. Up to 36 universal analog inputs, communicated inputs or math results can be recorded and displayed in a variety of operator views.

Standard 10BaseT Ethernet communications ensure full integration into PC networks for remote process monitoring and secure access to archived process data.

8Mb of onboard flash memory, capable of storing 2.8 million samples of data and the option of either SmartMedia or Compact Flash removable memory cards, provide extensive data storage capability.

A bright, clear high-contrast 31cm (12.1 in.) TFT display, Windows-style operation and configuration menus ensure clear and simple operator interface.

Application areas include:

- Environmental monitoring
- Water treatment plants
- Heat treatment
- Autoclaves
- Food, Dairy and Beverage processing
- Power Stations
- Cold storage
- Emission monitoring

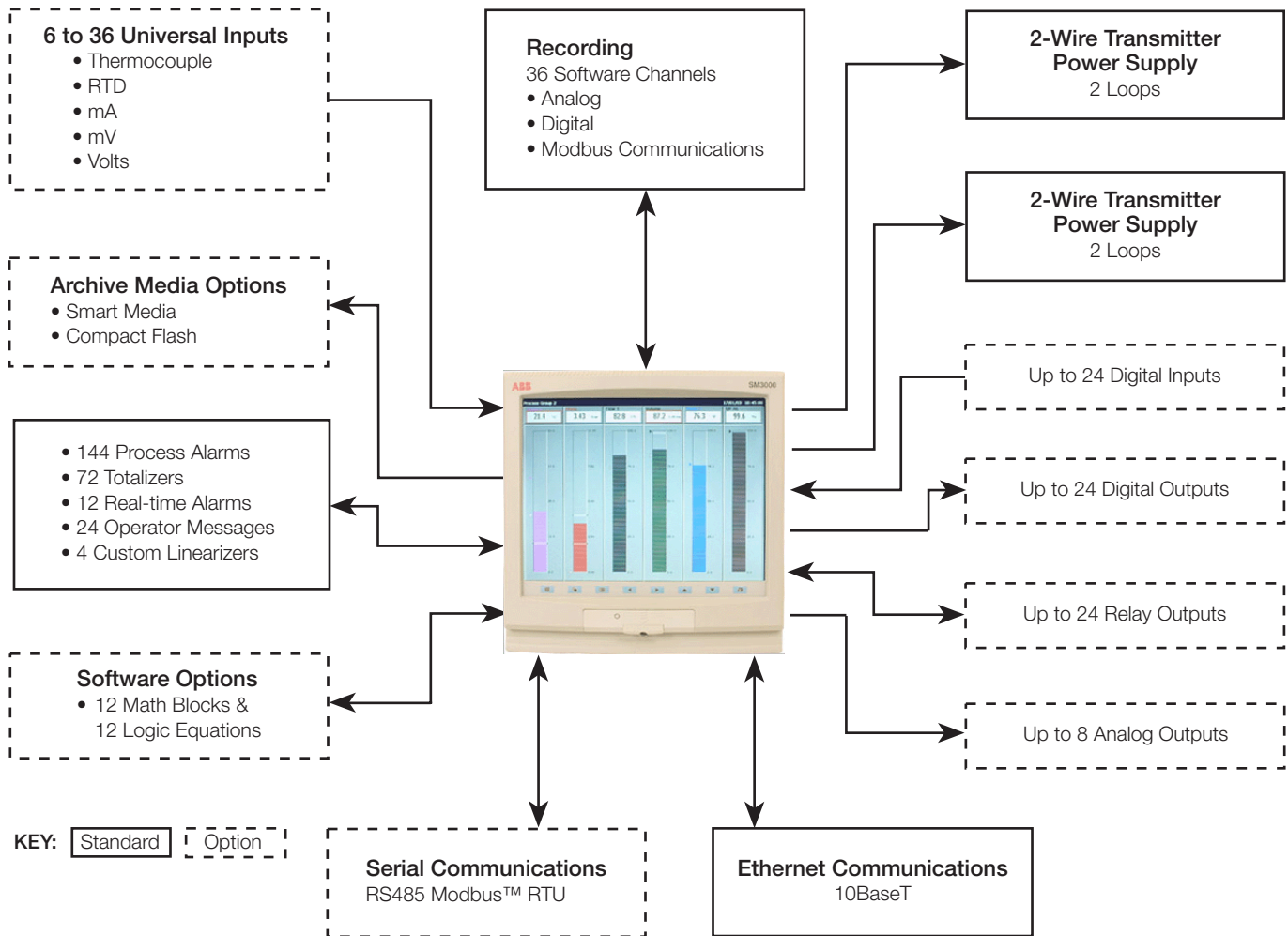

Advanced Process Recording

- 36 recording channels are provided as standard which can be used to record any analog, digital or communications (via Modbus) signal.
- Each group can be stored at it's own primary or secondary sample rate. This allows detailed information to be stored under specific process conditions, e.g. critical process states or alarm conditions. Alternatively, for simple applications one sample rate can be applied to all channels.
- Through the use of pre-storage filters it is possible to record the average, max./min. or instantaneous values of any recording channel.
- 8Mb of internal memory is provided for buffering of process data. Once this memory is full it wraps-around automatically and overwrites the oldest data, ensuring that the latest process data is always captured.
- All data recorded by the SM3000 is available to archive to the removable storage media. During periods when a card is not present or is full, data is still recorded into the SM3000's internal memory. When a card is inserted or space becomes available on the card unarchived data can be transferred to the card.

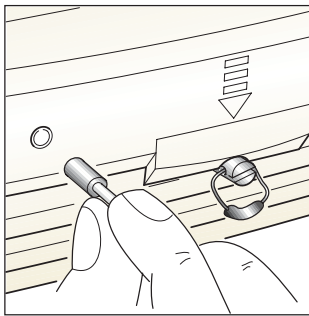
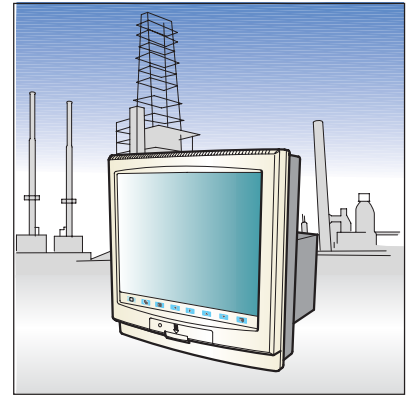

Security

- High specification data security compliant with 21 CFR Part 11.
 - A media door lock is fitted as standard to prevent unauthorized access to the memory card.
 - Multiple users can be configured, each with an individual user name and password. Comprehensive security options, including password expiry and configurable access levels, ensure the exceptional security of the SM3000.
 - Operator actions, data archiving events, configuration changes and other system occurrences are all saved to the audit log of the SM3000. Each entry is time, date and, where appropriate, stamped with a user ID, providing a comprehensive audit trail to accompany any data recorded by the SM3000.
- All data files contained within the SM3000's 8Mb of internal buffer memory, or created on memory cards, are encoded in a secure binary format ensuring that recorded data cannot be altered.
 - Two security modes are available for protection of the instrument's configuration. Multiple users can be configured, each with individual passwords and access levels or, as an alternative, a tamper-evident seal can be fitted to the front of the recorder. In this mode the configuration of the recorder can only be altered by first changing the position of an internal switch. To accomplish this the recorder must be removed from it's case, breaking the seal.

Guaranteed Data Integrity

- The use of Flash memory technology ensures that the SM3000 is not reliant on batteries to preserve stored data during a power failure.
- Data stored in the internal memory and on removable media is stored in small blocks with each block containing a checksum to ensure the integrity of that data.
- An advanced error detection/correction code is built into the internal Flash memory, ensuring safe storage of your process data.

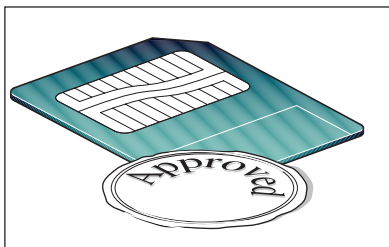
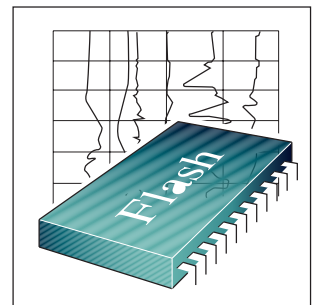

Industrial Standard, Robust, Archive Storage

- Either SmartMedia or Compact Flash memory card options can be fitted to the SM3000 for archive purposes. The solid-state nature of these devices ensures that the SM3000 can truly operate in ambient temperatures up to 50°C (122°F), whereas traditional electromagnetic floppy disk drives can operate only in temperatures up to 40°C (104°F).
- Every write to the archive storage media is verified to ensure the integrity of the data.

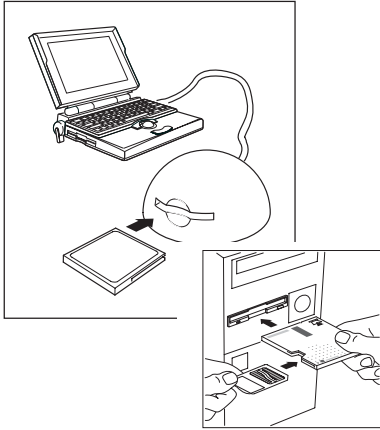

PC Interface for Archive Storage Media

Through the use of PC adapters for SmartMedia and Compact Flash, both options provide the advantages of very robust, solid-state storage with the convenience-of-use previously found only with floppy disks.

- Archives, stored on both Compact Flash and SmartMedia, can be accessed via a reader which plugs into the parallel, or USB, port of a desk/lap-top computer.
- A SmartMedia-to-floppy disk drive adapter enables SmartMedia cards to be read directly by the existing floppy disk drive on your computer.

Low Cost of Ownership

The large capacity of the SmartMedia and Compact Flash memory cards used by the SM3000 ensures that the requirement for operator intervention to transfer process data to a PC on a regular basis is greatly reduced. Older floppy disk technology, used by many other manufacturers of graphical recorders, limits storage capability significantly; sometimes to levels below the ability of a traditional paper recorder.

See below for an example of how memory storage times vary depending on the type of media device. The example shows the recording durations for a 6-channel recorder with a sample rate of 10s. Also included in the example is how these storage times compare with a traditional paper recorder.

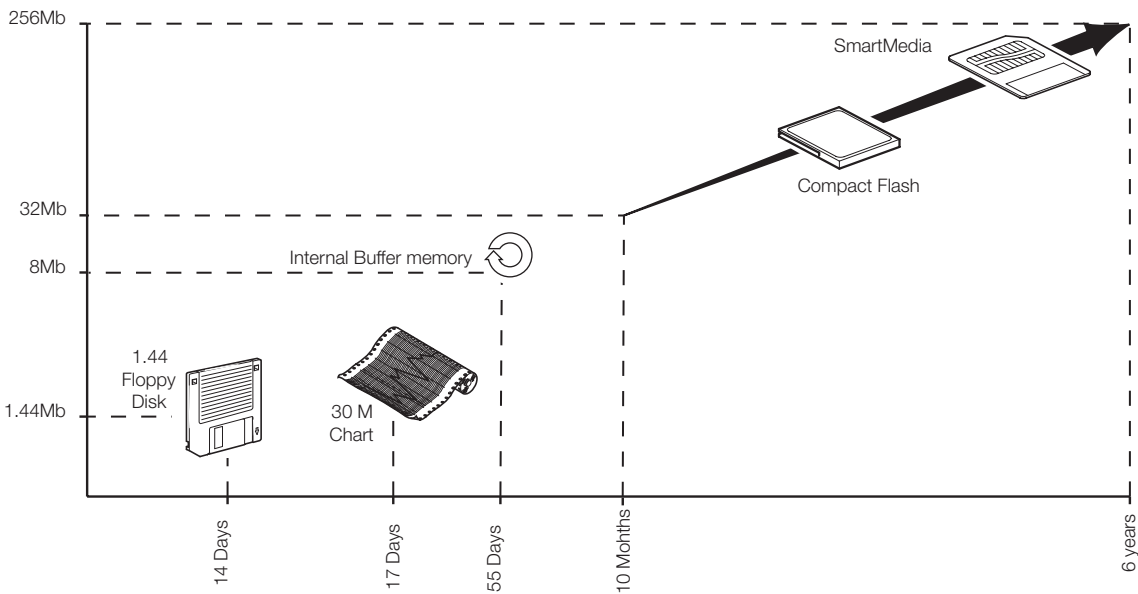



Unsurpassed Environmental Protection

Unique to this type of product, the SM3000 has unrivalled protection ratings of IP66 and NEMA4X and includes a fully-sealed, lockable media door. This enables the SM3000 to be installed, without additional protection, in applications that require frequent hosedown. With industrial standard noise emission and immunity protection, the SM3000 also operates effectively in high electrical-noise environments.

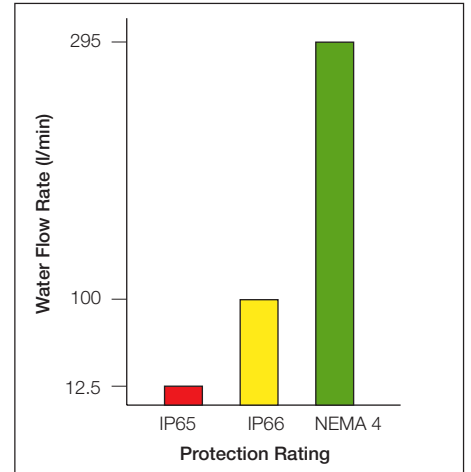

Intuitive User Interface

The interface displays a process data table for 'Group 1' and a historical trend chart. The table includes various parameters such as Temperature, Pressure, Flow, Volume, Valve status, and Levels. The chart shows trends for these parameters over time, with specific alarm events marked.

| Process Group | Temp 1 | Press. | Flow 1 | Volume | Temp 2 | Valve | Flow 2 | Level 1 | Level 2 | Tank 1 | Tank 2 | pur |
|---------------|---------|----------|----------|-------------|---------|-------|----------|---------|---------|---------|---------|----------|
| Group 1 | 20.0 °C | 4.33 bar | 76.2 l/h | 83.6 Litres | 76.1 °F | Close | 12.1 l/h | 98 cm | 227 cm | 7.40 pH | 9.74 pH | 1849 rpm |

Alarm Status: 08/02/03 09:38:02

Chart Trace: Shows trends for Temp 1, Press., Flow 1, Volume, Temp 2, Valve, Flow 2, Level 1, Level 2, Tank 1, Tank 2, and pur. The chart includes a scale bar and a 'Newest Data' indicator.

Alarm Events:

- 09:37:49 High Pressure
- 09:37:38 Low Pump Speed
- 09:36:38 Low Pump Speed
- 09:35:45 09:35:38 Low Pump Speed
- 09:35:20 High Pressure
- 09:35:01 High Pressure
- 09:34:48 Standby mode active
- 09:34:37 Low Pump Speed

Operator Message: 09:34:25

Navigation Keys:

- Group Key:** Selects between process groups and historical logs
- View Key:** Selects between enabled views for the selected process groups/logs
- Menu Key:** Displays a pop-up menu for operator selections
- Left/Right Cursor:** Used to navigate Configuration & review dates in historical review mode
- Up/Down Arrow:** Used to navigate pop-up menus and review data in historical review mode
- Enter:** Used for confirming menu selections

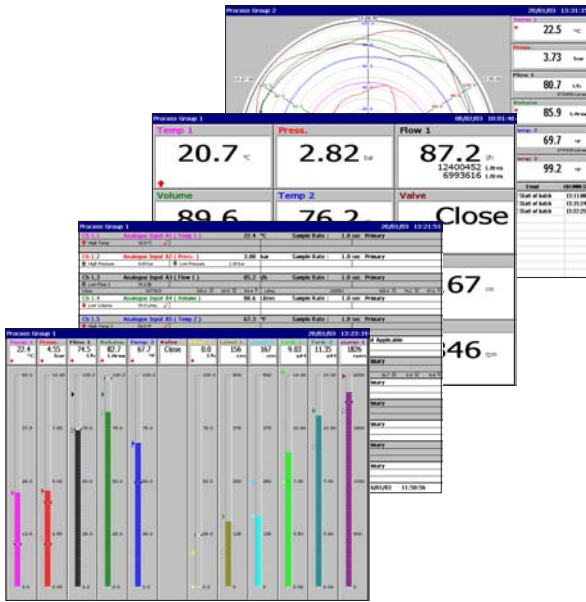

Operator Views

The 36 recording channels of the SM3000 can be freely distributed between 6 process groups and displayed using a number of different operator views. In addition to the standard strip chart views, the following views are available:

Circular Chart View

Up to six trends can be plotted on a circular chart. In addition to digital indicators, including alarm status and totalizer values, a log is constantly in view showing a list of recent alarm activity.

Digital Indicator View

Process value, engineering units, channel tag, totalizers and alarm status are all displayed clearly. An overview screen provides an at-a-glance view of all 36 recording channels.

Process View

Provides an at-a-glance summary of each channel, including detailed alarm, totalizer and statistical (min., max. & average) information.

Bargraph View

Horizontal or vertical formats, including min./max. and alarm trip point markers.

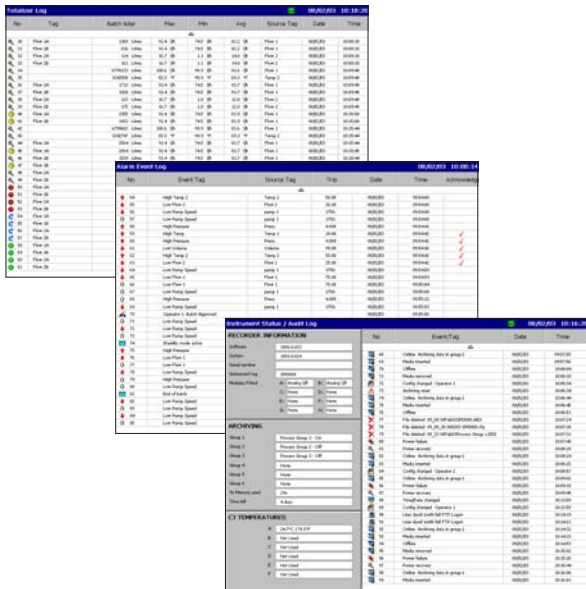

Historical Logs

Providing functions unavailable in paper-based recorders, three full time and date-stamped historical logs ensure complete validity of the recorder and its data. Any or all of these logs can be archived to the removable memory card.

Totalizer Log

All totalizer activity, e.g. starts, stops and resets, are recorded by the totalizer log. In addition individual log intervals can be configured for each totalizer, allowing total values to be logged regularly.

Alarm Event Log

A detailed history of all alarm occurrences, including active and inactive transitions plus acknowledgement details.

Audit Log

The highly-detailed secure log of all system events gathered by the Audit Log provides comprehensive evidence of the integrity, validity and traceability of data recorded by the SM3000. Included in the log are configuration changes, data archiving events, calibration adjustments, details of remote accesses and many more key events, all marked with operator IDs where applicable.

Configuration

A simple Windows-style structure provides an exceptionally easy approach to the setup of the SM3000. Text and numerical information is entered very quickly via an on-screen keyboard. Navigation of configuration menus is performed via the cursor keys and the pop-up menu.

It is also possible to configure the SM3000 via a Windows-based PC configuration package.

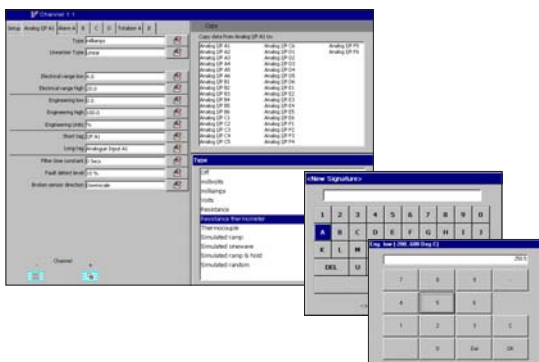

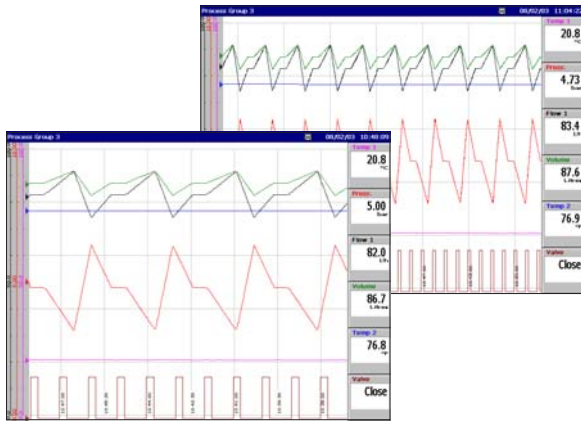

On-line Data Review

The SM3000 provides a number of unique features to provide a clear view of your process.

- The screen interval can be altered to display between 48s and 14 days of information, without it affecting the sample rate. This gives you the ability to 'zoom in' to a close-up view of the most current data or 'zoom out' to get the big picture.
- Individual traces can be temporarily removed from the screen to enable clear comparison of two or more trends.
- The SM3000 can easily review all historical data in the 8Mb internal buffer memory at the touch of a button. During this time, recording of the process data to the internal memory remains unaffected.

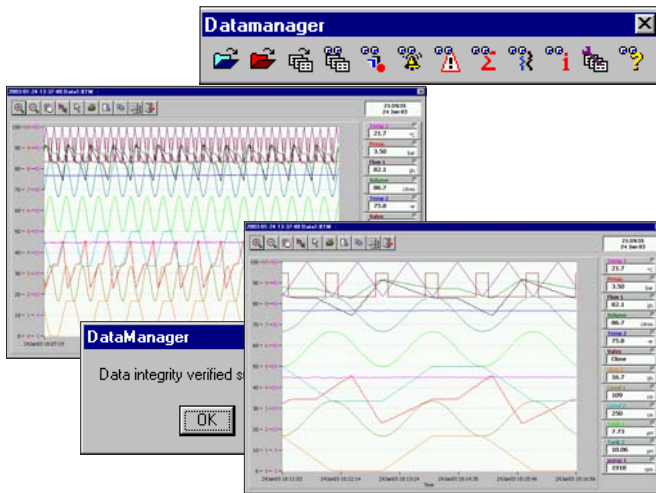

Off-Line Review and Analysis

Using ABB's DataManager software, archived process data and historical logs recorded to a removable media card can be reviewed easily.

- Database management of data files provided by DataManager ensures simple, secure long-term storage and retrieval of historical data.
- The graphing capabilities provided by DataManager ensure easy interrogation of process data.
- The validity of all data files is always checked by DataManager during the storage and retrieval process, ensuring maximum data integrity.

For further information on the capabilities of DataManager, refer to data sheet SS/DATMGR.

Math and Logic

Available as an option are advanced math and logic capabilities. 12 multi-element math and 12 multi-element logic equations can be configured. Equations can be nested into each other to provide extensive capabilities.

- Mean, standard deviation and rolling averaging functions are provided.
- Standard addition, subtraction, multiplication and division are complemented with Log, Ln, Square root, power, Sin, Cos, Tan and absolute functions.
- Switching of process signals can be achieved via the high/low/mid signal selection and multiplexing functions.
- Predefined equations are provided for relative humidity and F_0 measurements.
- AND, NAND, OR, NOR, XOR and NOT operators are available within the logic equations.

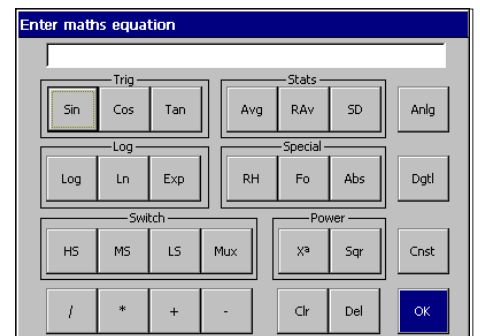

All math and logic equation results can be recorded on the display of the SM3000 and archived to the removable media. Detailed diagnostic functions are provided for both the math and logic equations.

Ethernet Communications

The SM3000 provides 10BaseT Ethernet communications as standard via a standard RJ45 connector. The SM3000 uses industry-standard protocols TCP/IP, FTP and HTTP enabling easy integration into existing PC networks.

Data File Access via FTP (File Transfer Protocol)

The SM3000 features FTP server functionality that provides high-speed access via Ethernet to data archived by the recorder.

- Using a standard web-browser or other similar FTP client, data files contained within the recorder's internal memory and removable memory card can be accessed remotely and transferred to a PC or network drive.
- 8 individual FTP users can be programmed into the SM3000. Access rights can be configured for each user specifying their access level.
- All FTP log-on activity is recorded in the audit log of the SM3000.
- Using the SM series complementary FTS (File Transfer Scheduler) software, data files from multiple recorders can be backed-up automatically to a PC or network drive for long term storage, ensuring the security of valuable process data and minimizing operator intervention.

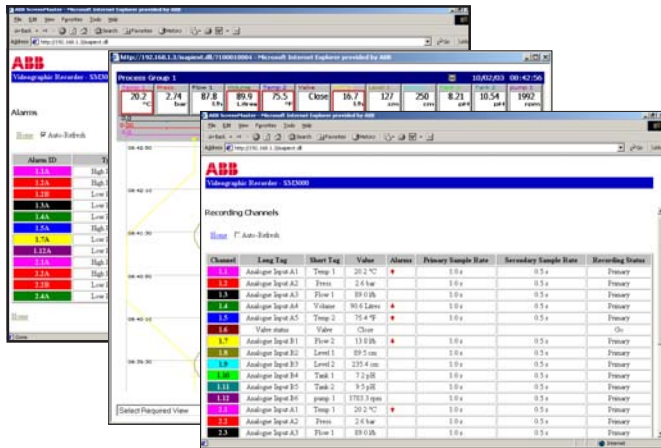
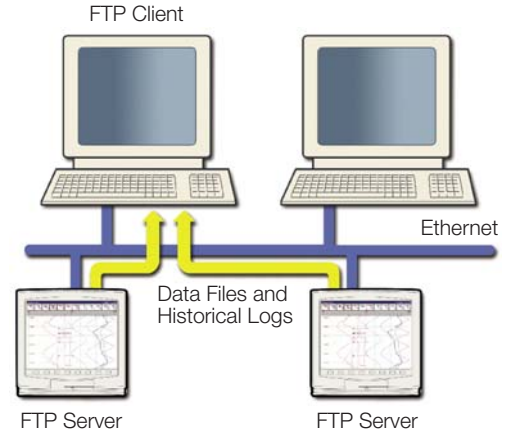

Embedded Web Server

Contained within the SM3000 is an embedded web-server, enabling access to web pages created within the recorder. The use of HTTP (Hyper Text Transfer Protocol) enables standard web browsers to view these pages.

- The web pages show the current display of the recorder, detailed information on process signals, alarm conditions, totalizer values, an overview screen showing the status of all 36 recording channels and other key process information.
- The historical logs stored in the SM3000's internal buffer memory can be displayed in full from within the web pages.
- Operator messages can be entered via the web server enabling comments to be logged to the recorder.
- All of the information displayed on the web pages is regularly refreshed enabling them to be used as a process supervision tool.

On-line Demonstration

A demonstration of these features is available from an on-line recorder accessible via the internet. In the address bar of your web browser enter 'http://217.33.207.105'.

Remote Access/Monitoring

Ethernet communications can provide a link to recorders installed in remote locations. By using a dial-up router, multiple SM3000 recorders can be installed in remote locations and accessed via a public telephone network when required.

Email Notification

Using its inbuilt SMTP client the SM3000 is able to email notification of important events. Emails triggered from process alarms or other critical process events can be sent to multiple recipients. The recorder can also be programmed to email reports of the current status at specific times during the day. Status report content can be tailored to suit your specific process needs.

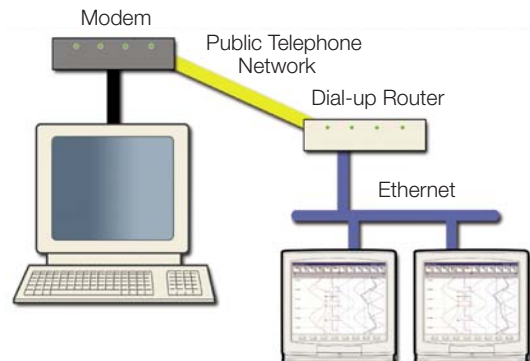

Specification

Operation and Configuration

Configuration

Via tactile membrane switches on front panel or
PC Configuration using removable media card

Multiple configuration files can be stored in internal (up to 5 files) or
external memory (with removable media option fitted)

Display

Thin film transistor (TFT), active-matrix, color, liquid crystal display
(LCD) with built-in backlight

Low-reflective, 31cm (12.1 in.) diagonal display area,
480,000 pixel display*

Viewing angle – Horizontal 55° typ. (left side, right side)

Vertical 50° from below, 40° from above

***Note.** A small percentage of the display pixels may be either
constantly active or inactive. Max. percentage of inoperative pixels
<0.01%.

Screensaver

Can be programmed to dim the backlight if operator keys are not
pressed for a selected period of time

Languages

English, German (French, Italian and Spanish pending)

Dedicated operator keys

- Group select
- View select
- Menu key
- Left cursor
- Right cursor
- Up/Increment key
- Down/Decrement key
- Enter key

Vertical chart screen intervals

Selectable from 48s to 14 days

Horizontal chart screen intervals

Selectable from 70s to 20 days

Circular chart duration

Selectable from 9 minutes to 32 days

Chart scales

Independent primary and secondary ranges for each channel

Vertical/horizontal chart divisions

Programmable for up to 10 major and 10 minor divisions

Circular chart divisions

Programmable up to 10 divisions

Chart annotation

Alarm and operator messages may be annotated on the chart

Icons to identify the type of event, time of occurrence and tag are
displayed

Operator Views

| Contents | Views Available | | | |
|-------------------------------------|-----------------|----------|-------------------|---------|
| | Chart | Bargraph | Digital Indicator | Process |
| Instantaneous values/states | ✓ | ✓ | ✓ | ✓ |
| Units of measure | ✓ | ✓ | ✓ | ✓ |
| Short tags | ✓ | ✓ | ✓ | ✓ |
| Long tags | | | | ✓ |
| Alarm status | ✓ | ✓ | ✓ | ✓ |
| Alarm trip markers | | ✓ | | |
| Alarm trip values | | | | ✓ |
| Max./Min. markers | | ✓ | | |
| Analog bargraphs | | ✓ | | |
| Totalizer values & units of measure | | | ✓ | ✓ |
| Totalizer tags | | | | ✓ |
| Max., min. and average batch values | | | | ✓ |
| Graphical view of historical data | ✓ | | | |

...Specification

Security

Configuration security

Password protection Access to configuration is allowed only after the user has entered a password

Internal switch protection Access to configuration is allowed only after a hardware switch has been set. This switch is situated behind a tamper evident seal

Setup security

Configuration Can be configured for password protection or free access to setup levels

Users

Number of users Up to 15

Usernames Up to 20 characters. Usernames are unique, i.e. names cannot be repeated

Access privileges Setup access – Yes/No
Electronic signature access – Yes/No

Configuration access – None/load file only/limited/full

Passwords Up to 20 characters

A minimum required password length of 4 to 20 characters can be configured and a password expiry time can be applied to eliminate password ageing

Password failure limit Configurable for 1 to 10 consecutive occasions or 'infinite'

A user is deactivated if a wrong password is entered repeatedly

Deactivation of inactive users Can be disabled or configured for 7, 14, 30, 60, 90, 180 or 360 days of inactivity

Users are deactivated (by removal of access privileges) after a period of inactivity

Electronic signature

Protection Only accessible to users with electronic signature access privileges

Access requires a valid username and password

Function Provides an electronic equivalent to the signing of a conventional paper chart

Enables operator to securely approve recorded data

Content Date/Time, operator ID and operator defined 20-character message are stored in the alarm/event log and can be displayed on the chart

Standard Functionality

Operator Messages

Number

24 configurable messages of up to 20 characters each

1 operator defined message of up to 20 characters

Trigger

Via front panel or digital signals

Recording in alarm/event log

Can be enabled or disabled on configuration

Process Alarms

Number

144 (4 per recording channel)

Update rate

Up to 12 alarms processed every 100ms, e.g. with 36 alarms enabled each alarm is updated once every 300ms

Types

High/low: process, latch & annunciator, delayed process

Rate: fast/slow

Tag

20-character tag for each alarm

Hysteresis

Programmable value and time hysteresis 1 to 9999s

Alarm enable

Allows alarm to be enabled/disabled via a digital input

Alarm log enable

Recording of alarm state changes in the alarm/event log can be enabled/disabled for each alarm

Acknowledgement

Via front panel or digital signals

Real-time Alarms

Number

12

Programmable

Day of the week, 1st of month, start and duration times

Totalizer

Number

72 (2 per recording channel) 10-digit totals

Type

Analog or digital, batch and secure totals

Statistical calculations

Average, maximum, minimum (for analog signals)

Date and time of max. and min. values

Update rate

Up to 4 totalizers processed every 100ms, e.g. with 12 totalizers enabled each total is updated once every 300ms

Custom Linearization

Number

4

Number of breakpoints

20 per linearizer

Number of channels v. number of groups

| Groups | Channels per Group |
|---------|--------------------|
| 1, 2, 3 | Up to 12 |
| 4 | Up to 9 |
| 5 | Up to 7 |
| 6 | Up to 6 |

Recording – To Internal Memory

Data Channels

Internal buffer memory

8Mb Flash memory provides storage for 2.9 million samples

Oldest data is automatically overwritten by new data when memory is full

Data integrity checks

Checksum for each block of data samples

48-bit code for error detection/correction built-in

Independent process groups

6

No. of recording channels

36

Sources

Analog inputs, Modbus inputs, any digital signal

Filters

Programmable for each channel to allow recording of: instantaneous values, average, max., min. and max. & min. value over sample time

Primary/secondary sample rates

Programmable from 0.1s to 12 hours for each process group

Primary/secondary sample rate selection

Via any digital signal or from password protected menu

Recording start/stop control

Via any digital signal or from password protected menu

Recording Duration

Approximate duration calculated for continuous recording of 12 channels of analog data (for 24 channels divide by 2, for 6 channels multiply by 2 etc.)

| Sample Rate | 1s | 10s | 40s | 60s | 120s | 480s |
|------------------------------|-----------------------|------------------------|-------------------------|-------------------------|-----------|------------------------|
| Internal Flash buffer memory | 2 ^{1/2} days | 27 ^{1/2} days | 3 ^{1/2} months | 5 ^{1/2} months | 11 months | 3 ^{1/2} years |

| Sample Rate | 1s | 10s | 40s | 60s | 120s | 480s |
|---------------------------------|----------|-----------|----------|----------|-----------|-----------|
| 128 Mb SmartMedia/Compact Flash | 2 months | 20 months | 7 years | 10 years | 20 years | 79 years |
| 256 Mb SmartMedia/Compact Flash | 4 months | 40 months | 13 years | 20 years | 39 years | 159 years |
| 512 Mb SmartMedia/Compact Flash | 8 months | 6 years | 26 years | 40 years | 79 years | 319 years |
| 1 Gb SmartMedia/Compact Flash | 1 years | 13 years | 52 years | 77 years | 155 years | 623 years |

Note. Windows CE limits the size of the card size to 2 Gb.

...Specification

Historical logs

Types

Alarm/Event, Totalizer and Audit logs

No. of records in each historical log

Up to 200 in internal memory

Oldest data is automatically overwritten by new data when log is full

Historical Logs

| Log Type | Alarm/Event Log | | Totalizer Log | | Audit Log | |
|--|------------------|-----------|---------------|-----------|-----------|-----------|
| Information Recorded in Logs | Log Entry Events | | | | | |
| | In Log | On Screen | In Log | On Screen | In Log | On Screen |
| Date & time of event | ✓ | ✓ | ✓ | ✓ | ✓ | ✓ |
| Type of event | ✓ | ✓ | ✓ | ✓ | ✓ | ✓ |
| Tag | ✓ | ✓ | ✓ | ✓ | | |
| Source tag | ✓ | | ✓ | | | |
| Alarm trip value & units of measure | ✓ | | | | | |
| Alarm state | ✓ | ✓ | | | | |
| Alarm acknowledgement state | ✓ | ✓ | | | | |
| Operator ID | ✓ | | | | ✓ | ✓ |
| Description | | | | | ✓ | ✓ |
| Batch total and units of measurement | | | ✓ | ✓ | | |
| Max., min. and average values plus units | | | ✓ | ✓ | | |
| Secure total | | | ✓ | | | |
| Time & date of min./max. values | | | ✓ | ✓ | | |

Archiving – To Memory Card

Removable storage media options

- None
- SmartMedia (3.3V only)
- Compact Flash

File types that can be saved to removable media

- Recorded data for each channel
- Alarm event log for each group
- Totalizer log for each group
- Audit log
- Configuration

File structure

Binary encoded with built-in data integrity checks

Automatic updating of archive files

- At regular time intervals according to the sample rate
- When a media card is inserted

Data verification

Carried out automatically on all writes to removable-media files

Analog Input Modules

General

Number of inputs

6 per board, max. of 36 inputs

Input types

Milliamps, millivolts, voltage, resistance, THC, RTD, digital input

Digital input types

| | |
|------------------------|-------------------|
| Type | Volt-free contact |
| Minimum pulse duration | 1s |

Thermocouple types

B, E, J, K, L, N, R, S, T

Resistance thermometer

PT100

Other linearizations

\sqrt{x} , $x^{3/2}$, $x^{5/2}$, custom linearization

Digital filter

Programmable 0 to 60s

Display range

-999 to 9999

Common mode noise rejection

>120dB at 50/60Hz with 300 Ω imbalance resistance

Normal (series) mode noise rejection

>60dB at 50/60Hz

CJC rejection ratio

0.05 $^{\circ}$ C/ $^{\circ}$ C

Sensor break protection

Programmable as upscale or downscale

Temperature stability

0.02%/ $^{\circ}$ C or 2 μ V/ $^{\circ}$ C

Long term drift

<0.2% of reading or 20 μ V annually

Input impedance

>10M Ω (millivolts inputs)
500k Ω (voltage inputs) externally mounted divider
10 Ω (mA inputs) externally mounted on terminals*

*Hart transmitters require a minimum 250 Ω loop impedance. A 250 Ω shunt resistor can be used together with the voltage divider board (GR2000/0375) to meet this requirement. In such cases the input should be programmed for 1 to 5V.

Standard/High Specification Analog Input Modules

| Linear Inputs | Standard Analog Input | High Specification Analog Input | Accuracy (% of reading) |
|---|---|--|--|
| Millivolts Milliamps Volts Resistance Ω | 0 to 2000mV 0 to 50mA 0 to +20V* 0 to 5000 Ω | -1000 to +1000mV -100 to +100mA -50 to +50V* 0 to 2000 Ω | 0.1% or \pm 10 μ V 0.2% or \pm 2 μ A 0.2% or \pm 10mV 0.2% or \pm 0.08 Ω |
| Sample Interval | 100ms per sample (2 modules are processed in parallel) gives worst case update times as follows: 600ms for 6 or 12 channels – mV, mA, voltage 800ms for 6 or 12 channels – THC 1100ms for 6 or 12 channels – resistance, RTD | 100ms per sample (2 modules are processed in parallel) gives worst case update times as follows: 100ms for 6 or 12 channels – all input types | |
| Input Isolation | 35V DC channel-to-channel | 500V DC channel-to-channel | |
| Isolation from Rest of Instrument | Galvanically isolated to 500V DC | Galvanically isolated to 500V DC | |

* Requires external voltage divider board Part No. GR2000/0375

...Specification

Analog Input Types

| Thermocouple | Maximum Range °C | Maximum Range °F | Accuracy (% of reading) |
|--------------|------------------|------------------|--|
| B | -18 to 1800 | 0 to 3270 | 0.1% or ±2°C (3.6°F) (above 200°C [392°F]) |
| E | -100 to 900 | -140 to 1650 | 0.1% or ±0.5°C (0.9°F) |
| J | -100 to 900 | -140 to 1650 | 0.1% or ±0.5°C (0.9°F) |
| K | -100 to 1300 | -140 to 2350 | 0.1% or ±0.5°C (0.9°F) |
| L | -100 to 900 | -140 to 1650 | 0.1% or ±1.5°C (2.7°F) |
| N | -1200 to 1300 | -325 to 2350 | 0.1% or ±0.5°C (0.9°F) |
| R | -18 to 1700 | 0 to 3000 | 0.1% or ±1°C (1.8°F) (above 300°C [540°F]) |
| S | -18 to 1700 | 0 to 3000 | 0.1% or ±1°C (1.8°F) (above 200°C [392°F]) |
| T | -250 to 300 | -400 to 550 | 0.1% or ±0.5°C (0.9°F) |

| RTD | Maximum Range °C | Maximum Range °F | Accuracy (% of reading) |
|-------|------------------|------------------|-------------------------|
| PT100 | -200 to 600 | -325 to 1100 | 0.1% or ±0.5°C (0.9°F) |

2-wire Transmitter Power Supply

Number

1 fitted as standard

Voltage

24V DC

Drive

Up to 45mA, i.e. can drive 2 loops

Ethernet

Physical medium

10BaseT

Protocols

TCP/IP, ARP, ICMP, FTP (server), HTTP

FTP server functions

Directory selection & listing

File upload/download

12 configurable users with full or read-only access

Web server functions

Operator screen monitoring/selection. Remote monitoring of recording channels, analog/digital signals, alarms, totalizers and archiving

Advanced Math

Math Blocks

Type

12 equations provide ability to perform general arithmetic calculations including F_0 , mass flow, relative humidity and emissions calculations

Size

40-character equation

Functions

+, -, /, log, Ln., Exp, X^n , $\sqrt{\quad}$, Sin, Cos, Tan, mean, rolling average, standard deviation, high/median/low select, multiplexer, absolute, relative humidity

Tags

8- and 20-character tags for each block

Update rate

1 enabled block every 100ms

Logic Equations

Number

12

Size

11 elements each

Functions

AND, OR, NAND, NOR, XOR, NOT

Tags

20-character tag for each equation

Update rate

300ms

Modules

3- or 6-Relay Output Modules (max. of 4 Modules)

Number of relays

3 or 6 per module, max. of 4 modules (24 relays)

Type and rating

| | | |
|-------------------------|------------------------|--------|
| Relay type | single-pole changeover | |
| Voltage | 250V AC | 30V DC |
| Current | 5A AC | 5A DC |
| Loading (non-inductive) | 1250VA | 150W |

Note. The total load for all relays within the instrument must not exceed 36A.

Hybrid Module (max. of 4 Modules)

Digital I/O

| | |
|--------------------------|--|
| Number | 6 inputs and 6 outputs per card |
| Type | Volt-free switching inputs |
| Polarity | Negative, i.e. closed switch contact or 0V = active signal |
| Digital input min. pulse | 125ms |
| Digital output voltage | 5V |
| Isolation | 500V DC from any other I/O |

Analog output

| | |
|----------------------------|----------------------------|
| Number | 2 isolated |
| Configurable current range | 0 to 20mA |
| Max. load | 750Ω |
| Isolation | 500V DC from any other I/O |
| Accuracy | 0.25% |

2-wire Transmitter Power Supply Module (max. of 2 Modules)

Number

2 isolated supplies per module

Voltage

24V DC nominal

Drive

45mA per supply, i.e. each module can drive 2 x 2 = 4 loops

RS485 Serial Communications Module (Max. of 1 Module)

Number of ports

1

Connections

RS485, 2- or 4-wire

Protocol

Modbus RTU slave

...Specification

EMC

Emissions & immunity

Meets requirements of:
EN50081-2
EN50082-2
EN61326 for an industrial environment

Electrical

Power supply

90V min. to 265V max. AC 50/60Hz
24V DC \pm 2.4V (optional, pending)

Power consumption

35VA max

Power interruption protection

No effect for interruptions of up to 20ms

Maximum accepted cable size

| | |
|---------------------------|-------------------|
| Instrument terminal block | 14AWG (1.63mm OD) |
| GR2000/0375, GR2000/0377 | 15AWG (1.45mm OD) |

Safety

General safety

EN61010-1
Overvoltage Class III on mains, Class II on inputs and outputs
Pollution category 2

Isolation

500V DC to earth (ground)

Environmental

Operating temperature range

0 to 50°C (32 to 122°F) with SmartMedia/Compact Flash

Operating humidity range

5 to 95%RH (non-condensing)

Storage temperature range

-20 to 60°C (-4 to 140°F)

Front panel sealing

IP66 and NEMA4X

Rear panel sealing

(with rear cover) IP40
(without rear cover) IP20

Physical

Size

288mm (11.34in.) x 288mm (11.34in.) x 195mm (7.68 in.)
(depth behind panel)

Weight

8kg (17.64 lb) approx. (unpacked)

Panel cutout

281mm (11.06 in.) x 281mm (11.06 in.)

Case material

20% glass-filled polyester/stainless steel (grade 304)

Display housing material

25% glass-filled polyester

Screen

Double layer polyester coated toughened glass

Electrical Connections

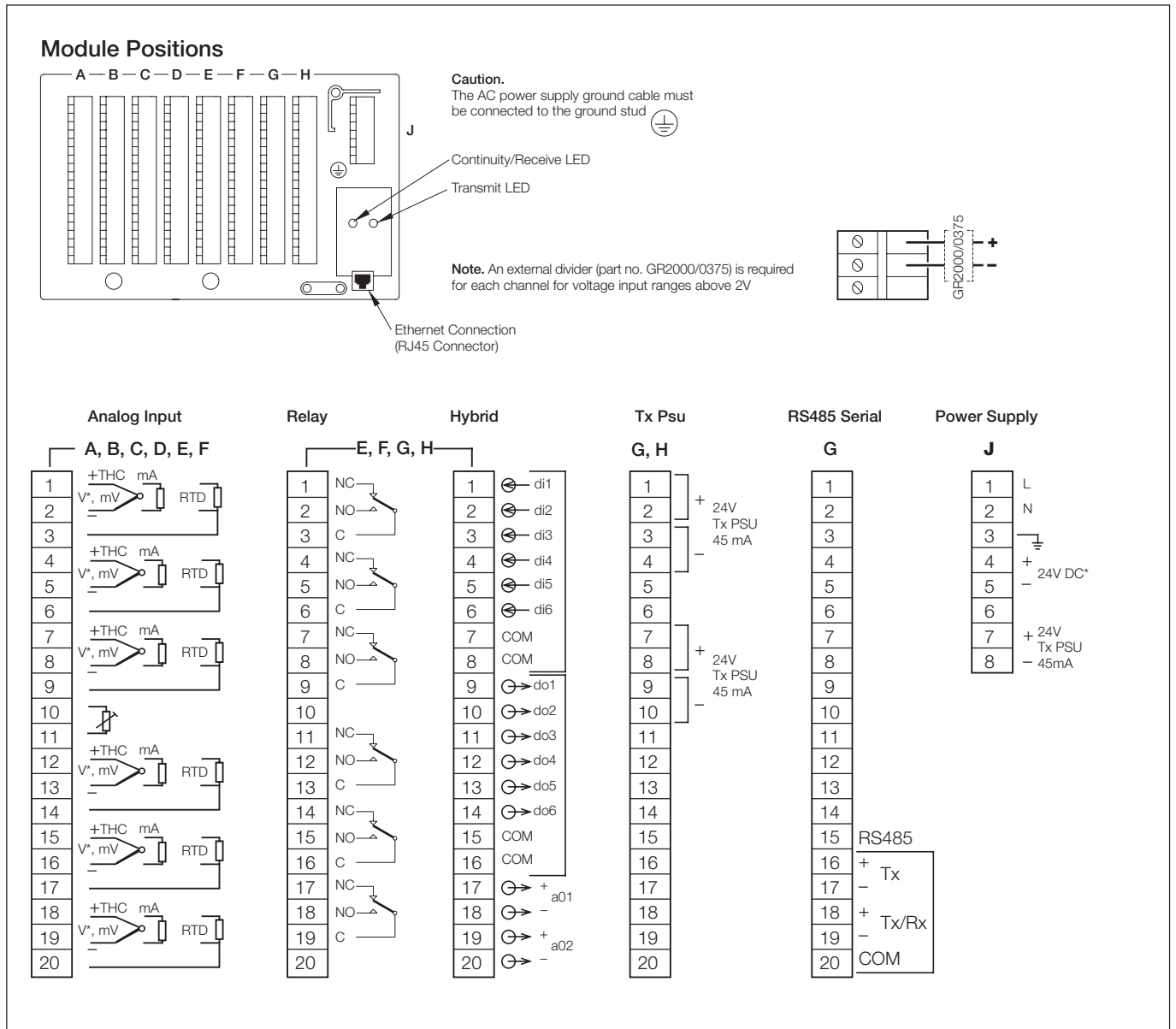

*Note. 24V DC instrument power supply must be specified when ordering.

Overall Dimensions

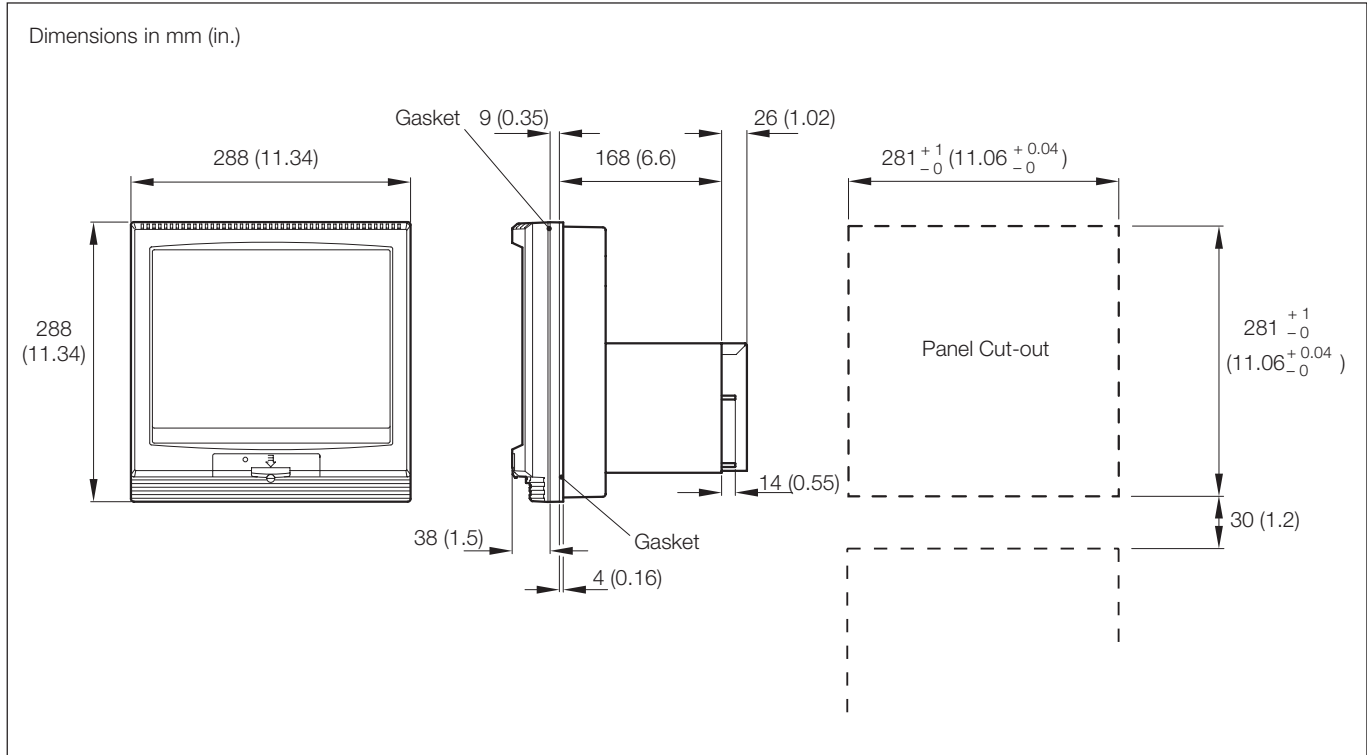

Optional Accessories

| Part No. | Description |
|----------|-------------|
|----------|-------------|

SmartMedia Cards

| | |
|--------|-------------------------|
| B11862 | SmartMedia Card (64Mb) |
| B11863 | SmartMedia Card (128Mb) |

Compact Flash Cards

| | |
|--------|----------------------------|
| B11867 | Compact Flash Card (128Mb) |
|--------|----------------------------|

Card Reader

| | |
|--------|---------------------------------------|
| B12028 | Compact Flash Reader (USB Interface)* |
|--------|---------------------------------------|

Other

| | |
|-------------|--|
| GR2000/0375 | Voltage divider board (2 to 20V) – per voltage input channel |
| GR2000/0375 | Voltage divider board fitted with a 250Ω shunt resistor |

SW/DATMGR DataManager Software

* Compatible with Windows 98/98se, ME, 2000 & XP

Licensing, Trademarks and Copyrights

Windows™ is a trademark of the Microsoft Corp.

Modbus™ is a trademark of Modicon, Inc.

Ordering Information

| Multipoint Videographic Recorder | SM30 | XX | X | X | X | X | X | X | X | X | X | X | X | X | X | X | X | X | XXX |
|---|--|----|---|---|---|---|---|---|---|---|---|---|---|---|---|---|---|---|-----|
| Analog Inputs | | | | | | | | | | | | | | | | | | | |
| None | | 00 | | | | | | | | | | | | | | | | | |
| 6 inputs | | 06 | | | | | | | | | | | | | | | | | |
| 12 inputs | | 12 | | | | | | | | | | | | | | | | | |
| 18 inputs | | 18 | | | | | | | | | | | | | | | | | |
| 24 inputs | | 24 | | | | | | | | | | | | | | | | | |
| 30 inputs | | 30 | | | | | | | | | | | | | | | | | |
| 36 inputs | | 36 | | | | | | | | | | | | | | | | | |
| Universal Inputs | | | | | | | | | | | | | | | | | | | |
| Standard | | | S | | | | | | | | | | | | | | | | |
| High specification | | | H | | | | | | | | | | | | | | | | |
| Build Option | | | | | | | | | | | | | | | | | | | |
| Standard | | | | B | | | | | | | | | | | | | | | |
| cCSAus (pending*) | | | | C | | | | | | | | | | | | | | | |
| Archive Media | | | | | | | | | | | | | | | | | | | |
| None – (8Mb internal flash memory only) | | | | | 0 | | | | | | | | | | | | | | |
| SmartMedia drive | | | | | 1 | | | | | | | | | | | | | | |
| Compact flash drive | | | | | 2 | | | | | | | | | | | | | | |
| Software Option | | | | | | | | | | | | | | | | | | | |
| None | | | | | 0 | | | | | | | | | | | | | | |
| Advanced Math | | | | | 1 | | | | | | | | | | | | | | |
| Option Modules | | | | | | | | | | | | | | | | | | | |
| Position A | Reserved for analog inputs | | | | | 0 | | | | | | | | | | | | | |
| Position B | Reserved for analog inputs | | | | | | 0 | | | | | | | | | | | | |
| Position C | Reserved for analog inputs | | | | | | | 0 | | | | | | | | | | | |
| Position D | Reserved for analog inputs | | | | | | | | 0 | | | | | | | | | | |
| Position E | None (only option available if 30 or more analog inputs) | | | | | | | | | 0 | | | | | | | | | |
| | 3 relays | | | | | | | | | 3 | | | | | | | | | |
| | 6 relays | | | | | | | | | 6 | | | | | | | | | |
| | Hybrid | | | | | | | | | H | | | | | | | | | |
| Position F | None (only option available if 36 analog inputs) | | | | | | | | | | 0 | | | | | | | | |
| | 3 relays | | | | | | | | | | 3 | | | | | | | | |
| | 6 relays | | | | | | | | | | 6 | | | | | | | | |
| | Hybrid | | | | | | | | | | H | | | | | | | | |
| Position G | None | | | | | | | | | | | 0 | | | | | | | |
| | 3 relays | | | | | | | | | | | 3 | | | | | | | |
| | 6 relays | | | | | | | | | | | 6 | | | | | | | |
| | Hybrid | | | | | | | | | | | H | | | | | | | |
| | 2-wire transmitter power supply | | | | | | | | | | | | T | | | | | | |
| | RS485 serial communications | | | | | | | | | | | | S | | | | | | |
| Position H | None | | | | | | | | | | | | | 0 | | | | | |
| | 3 relays | | | | | | | | | | | | | 3 | | | | | |
| | 6 relays | | | | | | | | | | | | | 6 | | | | | |
| | Hybrid | | | | | | | | | | | | | H | | | | | |
| | 2-wire transmitter power supply | | | | | | | | | | | | | T | | | | | |
| Mechanical Build | | | | | | | | | | | | | | | | | | | |
| Without rear terminal cover | | | | | | | | | | | | | | | | | | | 1 |
| With rear terminal cover | | | | | | | | | | | | | | | | | | | 2 |
| Power Supply | | | | | | | | | | | | | | | | | | | |
| 90V min. to 265V max. AC | | | | | | | | | | | | | | | | | | | 2 |
| 24V DC (pending*) | | | | | | | | | | | | | | | | | | | 3 |
| Language | | | | | | | | | | | | | | | | | | | |
| English | | | | | | | | | | | | | | | | | | | E |
| French (pending*) | | | | | | | | | | | | | | | | | | | F |
| German | | | | | | | | | | | | | | | | | | | D |
| Italian (pending*) | | | | | | | | | | | | | | | | | | | I |
| Spanish (pending*) | | | | | | | | | | | | | | | | | | | S |
| Special Features | | | | | | | | | | | | | | | | | | | |
| Standard | | | | | | | | | | | | | | | | | | | STD |
| Custom configuration | | | | | | | | | | | | | | | | | | | CUS |

* For more information contact your local Sales Office.

ABB has Sales & Customer Support
expertise in over 100 countries worldwide

www.abb.com

The Company's policy is one of continuous product
improvement and the right is reserved to modify the
information contained herein without notice.

Printed in UK (09.06)

© ABB 2006



ABB Limited
Howard Road, St. Neots
Cambridgeshire
PE19 8EU
UK
Tel: +44 (0)1480 475321
Fax: +44 (0)1480 217948

ABB Inc.
125 E. County Line Road
Warminster,
PA 18974
USA
Tel: +1 215 674 6000
Fax: +1 215 674 7183