

- **24-channel recording on 250mm chart**
 - with individual trace colors
- **Universal process inputs**
 - accepts thermocouples, RTDs, mA, mV & V
- **Totalizers, math and logic equations**
 - advanced processing capabilities
- **Modbus™ serial communications**
 - provide full integration with your control system
- **Unique Cue-and-Review incident analysis**
 - historical data at the touch of a button
- **High clarity graphics display**
 - shows process status at a glance
- **Dust- and water-resistant to IP65 (NEMA3)**
 - for harsh industrial environments
- **PC memory card data storage**
 - full data logging and configuration back-up



SR250A – all the processing power you need in a rugged, compact 250mm recorder

SR250A

The SR250A is a 250mm strip chart recorder providing accurate and reliable recording of up to 24 channels. The SR250A also provides a range of advanced processing capabilities such as flow totalization, math blocks, logic equations, configurable displays and full message printing.

With the option to fit PC memory card data storage, RS485 Modbus communication and up to 18 alarm relays, the recorder becomes a very powerful signal processing tool.

To assist the operator in analyzing any process problem the SR250A has a unique Cue-and-Review system, allowing the user to examine historical data anywhere on the chart at the push of a button.

The SR250A can be supplied for panel mounting or for portable use. The front fascia, rated IP65 (NEMA 3), is resistant to hosedown and dusty environments

Application areas include:

- Furnace Surveys
- Water treatment plants
- Large Cold stores
- Stack gas monitoring
- Sterilizer surveys
- Laboratories

Process Connections

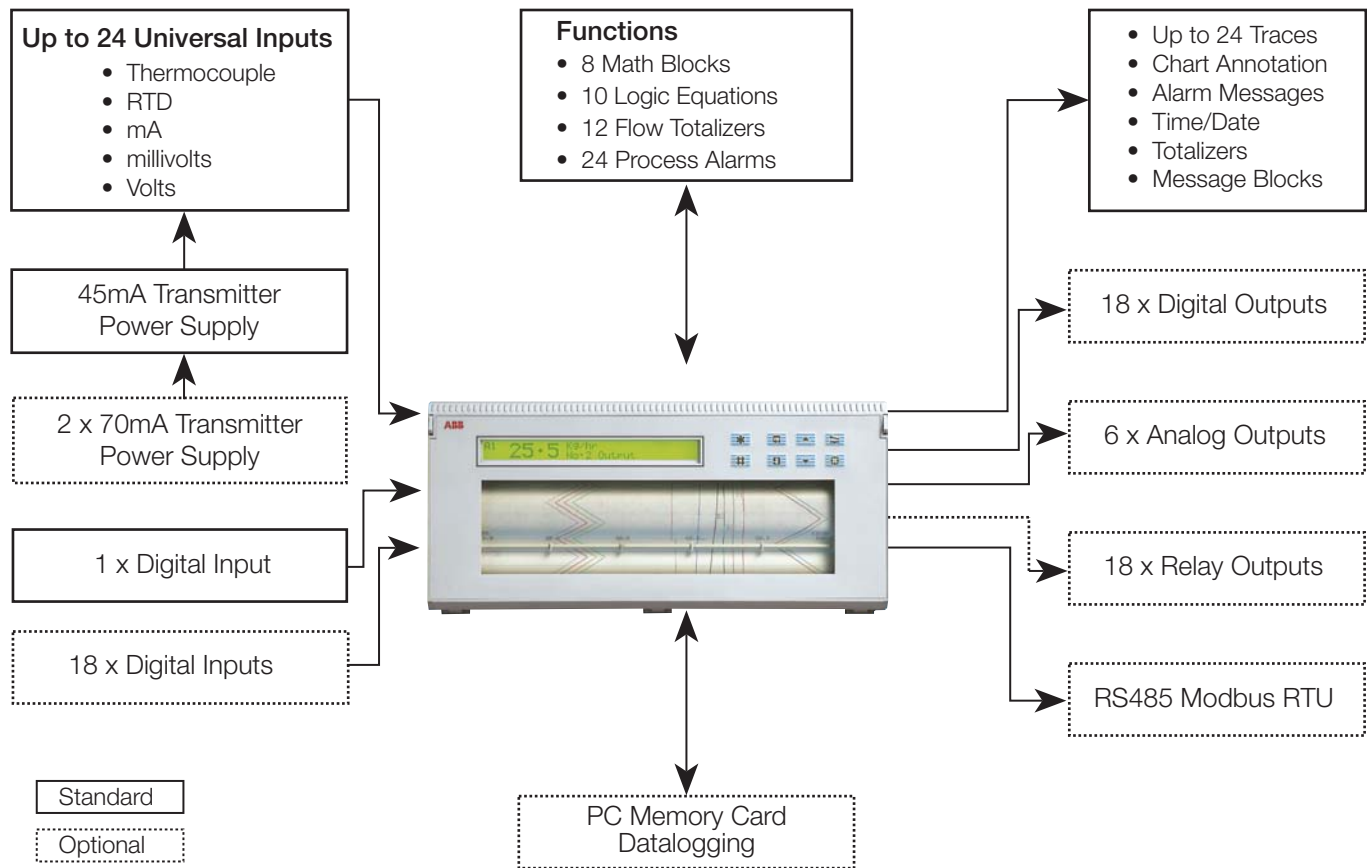

Recording

The SR250A's high-speed multi-point printing system updates all 24 traces in 3 seconds. This system produces continuous lines on the chart for speeds of up to 500mm/hr.

The printing sequence is intelligently managed by the recorder's control system to give priority to fast-changing signals or events, ensuring the most comprehensive process record is traced on the chart.

The SR250A supports full text printing to provide detailed annotation on the chart. In addition to the time, date, channel identity and chart speed, the recorder can print scales for each channel, alarm messages, totalizer values and an operator-defined batch name.

The 'Easy-view' facility enables the user to see the latest recordings at the push of a button.



Unique Post-Incident Analysis (Cue-and-Review)

The SR250A's unique Cue-and-Review feature allows the user to rapidly search any part of the roll chart, process event or alarm occurrence – enabling rapid and accurate analysis of process records.

The 10 most recent alarms are held in a buffer, allowing the user to examine the order of process incidents and to review the corresponding part of the chart for detailed evaluation.

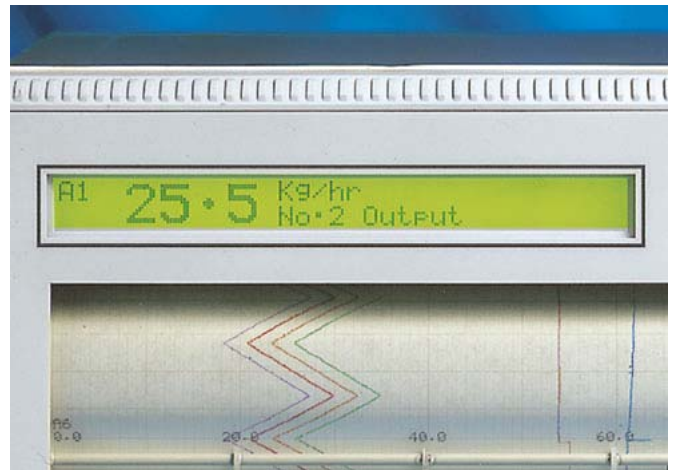

Operation

A graphic liquid crystal display (LCD) provides a choice of five different display formats to suit the application.

During normal operation the display cycles through each channel in sequence.

Clear text prompts on the LCD assist the operator in accessing functions such as chart reload and alarm acknowledge. Tactile membrane keys on the front of the recorder are used to access these functions. A second, identical keypad is provided inside the recorder for use when the door is open.

Password protection prevents unauthorized access to the recorder's configuration.

Quickly-fitted pen cartridges and an easily-removable chart cassette ensure simple and efficient pen and chart replacement.

Set-up

The SR250A can be easily set up to match your process in either of two ways:

For small changes the simplest method is by means of the keypad on the front of the unit. Entry of the correct password gives access to the recorder's configuration. A simple menu structure with clear text descriptions provides an intuitive approach to the recorder set-up.

The fastest way to set up multiple SR250A recorders is by means of the PC Configurator. This Windows™-based package provides a simple 'point-and-click' approach to generating a full recorder configuration off-line. The completed configuration can be printed-out or saved onto disk before being downloaded to the recorder.

An interface cable is used to provide the connection between the PC's serial port and the configuration port on the recorder.

Chart Annotation

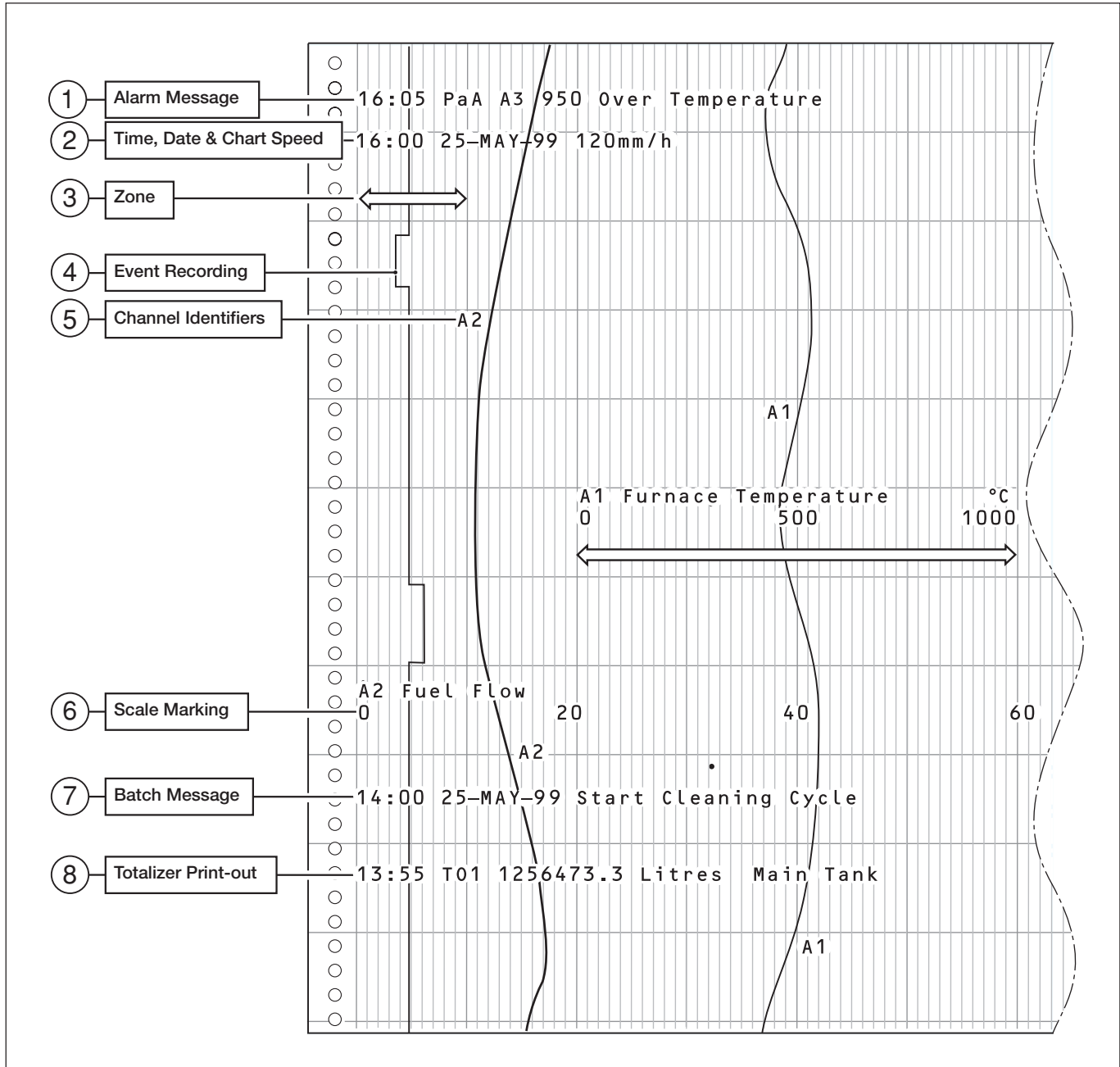

① **Alarm Message**

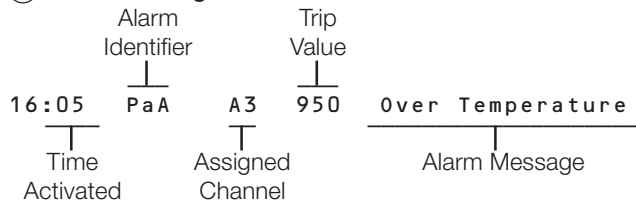

② **Time, Date & Chart Speed** – printed on power-up and at 240mm intervals (approx.). The time is printed every 60mm (approx.).

③ **Zone** – the 250mm chart width can be split into zones. (10 max.). The zone margins can be set to any major chart division and traces can be configured to record in any zone. Zones can overlap.

④ **Event Recording** – assigned to digital inputs and alarms. Any trace can be configured as a 3-position event marker, recording in the centre of the zone, with a 3mm deviation when a digital input is active.

⑤ **Channel Identifiers** – one identifier per trace.

⑥ **Scale Marking** – one scale per trace, printed across the width of the zone, at intervals of 20 to 240mm.

⑦ **Batch Message** – printed on demand from a digital signal or via the front panel keys.



⑧ **Totalizer Print-out** – printed at programmable intervals (between 5 and 720 minutes).

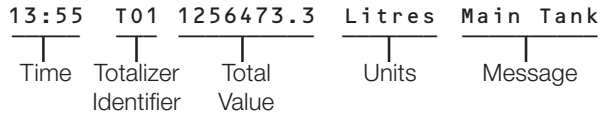

Option Modules

All recorders are fitted with at least one universal input module for analog process signals, plus a transmitter power supply for up to two 4 to 20 mA devices.

The capabilities of your recorder can be extended by the addition of further option modules. Each recorder can support up to 4 Input Modules plus 3 Option Modules.

Type	Standard	Option
Universal Inputs	3, 6, 9, 12, 15, 18, 21 or 24	
Relay	0	18
Transmitter Power Supply	2	12
Serial Communications	X	✓
Digital inputs	1 *	18
Digital outputs	0	18
Analog outputs	0	6

* Per universal input module



Memory Card Data Storage

The SR250A supports a simple plug-in, PCMCIA card-based logging system with the ability to record data from up to 24 process signals. The information is stored in DOS format which can be imported easily by the majority of standard spreadsheets. On applications which do not run continuously, the data logging can be started or stopped from an external digital source.

Configuration 'Save-and-Restore' is also supported by the card, allowing rapid downloading of frequently-used configurations and simple copying from one recorder to another.

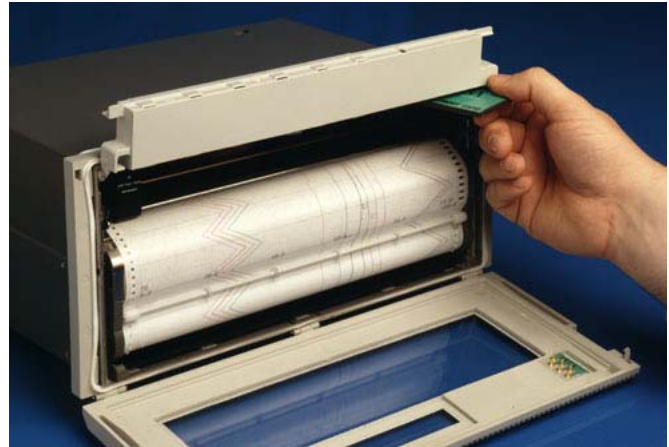

Mounting Options

Instead of standard panel clamps the SR250A can be supplied with a rugged carrying case, making it ideal for bench-top or on-site use.

The carrying case, combined with the recorders' light weight, provides a perfect instrument for survey work.

Innovative Design

Mechanical and electrical component count is minimized for improved performance and reliability.

An advanced analog/digital design ensures long term stability and allows range changes to be made without the need for recalibration.

Exceptional immunity to RF interference, electrical noise and line dropout (brown-out) conditions, together with the IP65 (NEMA3) rated front face, ensure reliable operation – even in harsh industrial environments.

Long life, plug-in print cartridges with 25m roll or 12m fanfold charts, both with quick-loading cassettes, and speeds from

1 to 1500mm/hr ensures minimal operating costs.

Modbus Serial Communications

The RS485 serial communications link enables the SR250A to interface with SCADA systems, PLCs or plant-wide data gathering networks.

All process information can be read over the link in real time by a host computer using Modbus RTU communications protocol.

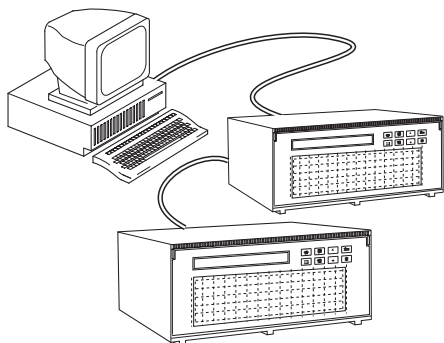

Applications

Temperature Recording

Recording of temperature, using both direct-connected thermocouples and RTDs or 2-wire field-mounted transmitters, is common in a wide range of industries such as Aerospace, Car component, Food, Chemical and Kiln/Ovens.

The SR250A can accept direct connection to all standard thermocouples, Pt100 resistance thermometers and 4 to 20mA transmitters, and record on up to 6 channels or datalog up to 12 inputs.

Operator messages allow printing of configurable messages such as 'Start of Test' or 'Cycle Complete' for a clear record of the batch.

For electric ovens fit the 500V isolator card to avoid conductance on the thermocouple which causes noise on the chart.

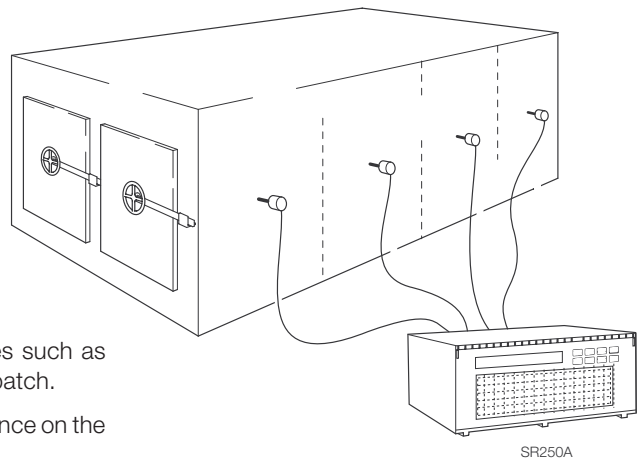

Temperature Monitoring and Alarms

In food production, it is essential to monitor the conditions in Cold Stores and Temperature-controlled Rooms to provide the user with a record that the goods have been stored at the correct temperature.

The simplest and easiest way to do this is with the SR250A strip chart recorder, which can take upto 6 inputs from RTDs spread across a cold store or a number of food preparation areas.

At a chart speed of 20mm/hour, the unit provides recording for one month and, when fitted with relay output modules, provides alarm functions.

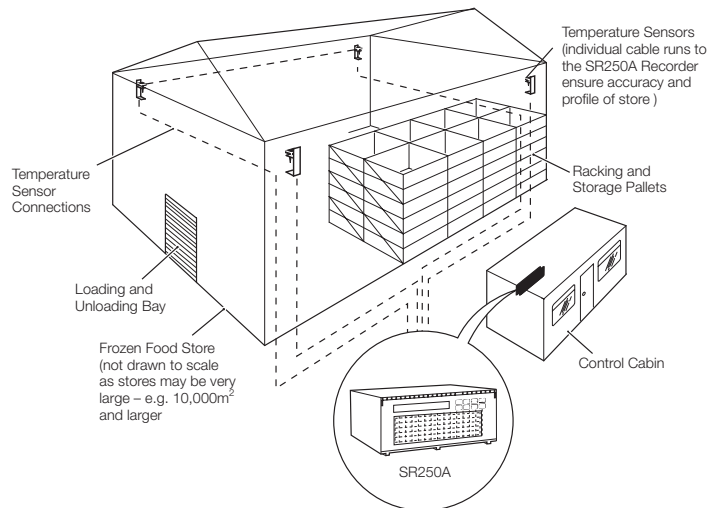

Waste Monitoring and Control

The discharge of effluent into rivers and streams is very tightly controlled and the need to prove that the regulations have been met is extremely important. The simplest way is to use a chart recorder connected to the pH transmitter in the discharge line.

Flow rates can also be monitored with the added advantage of having multiple totalization.

For example, of the 6 totalizers available, one may be a continuous (non-resettable) total and another can be a weekly (resettable) total.

Totals can be printed on the chart along with the time, date and alarm conditions.

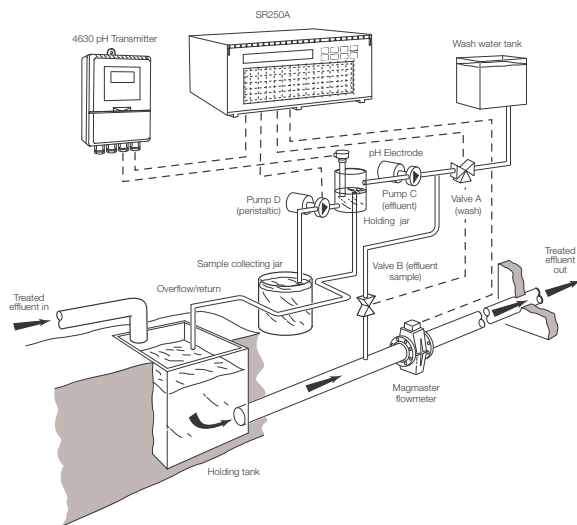

Summary Specification

1548097

The SR250A includes, as standard, 12 independent flow totalizers. These can be programmed to count up or down, with 'end-of-batch' alarm if required.

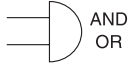

Internal soft wiring of functions using 10 logic equations minimizes installation costs and maximises functionality.

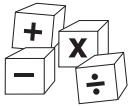

There are 8 math blocks available, each with up to 3 inputs. Also included are preset math blocks for mass flow, %RH, max., min. and average calculations.

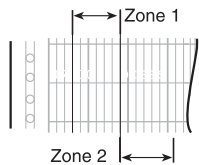

Up to 10 programmable zones can be selected on the chart. The size of each zone is variable and can be set by the user.

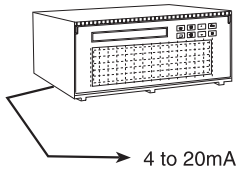

Six analog outputs can be fitted for retransmission of any input signal or math function result.

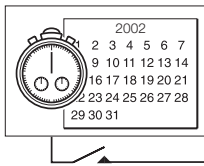

Four event timers can be set to activate hourly, daily or weekly and can be used in logic equations.

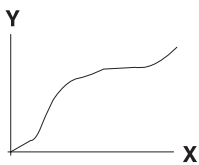

Included as standard are two 20-breakpoint custom linearizers for use on non-standard thermocouples, tank level or other unusual input ranges.



Up to 24 process alarms can be set up within the recorder. The alarms can be used to operate relay outputs, print messages on the chart or change the chart speed.

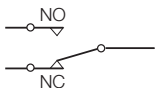

A maximum of 18 relays can be fitted within the recorder for use as alarm outputs. A single common relay can be set up to be triggered by multiple alarms.

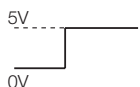

Up to 18 digital inputs can be fitted for remote changing of chart speed, alarm acknowledgment, input to logic equations and event recording.

Specification

Summary

Choice of 3, 6, 9, 12, 15, 18, 21 or 24 traces
250mm wide roll chart
Fully user-programmable
IP65 (NEMA3) protection

Chart

Traces

1 trace per input channel, analog trend or 3-position event

Colors

Magenta, red, black, green, blue and brown basic plus
18 multicolor Z-traces

Pen life

3 months typically (at 20mm/hr with normal scale printing)

Chart

25m Roll chart
Quick-load cassette
Standard chart graduation 100 divisions
80, 120, 140, 150 divisions also available

Chart speed

Configurable between 1 and 1500mm/hr in 1mm/hr steps
Logic or switch selectable at three configured speeds and
stop (0mm/h)

Trace response

3s for update of 24 traces max.
2.2s for update of 12 traces max.
1.5s for update of 6 traces max.

Trace resolution

0.2mm

Operation

Graphics display – backlit LCD

Characters 10.4mm or 5.1mm high

Display of Programming/Configuration

Five selectable operator displays:

- 1) Large PV + engineering units + channel tag
- 2) Large PV + engineering units + totalizer value
- 3) 3 x PVs + engineering units
- 4) PV + engineering units + 200-element bargraph
- 5) Digital signals + text on/off message

Languages

User-configurable for English, French or German

Switches

Sealed tactile membrane duplicate keypads on door and inside
case

Security levels

All levels are protected by a user-configured password

...Specification

Analog Inputs

Number

3, 6, 9, 12, 15, 18, 21 or 24 Standard Analog Inputs

Input sampling rate

125ms per channel – 24 channels in 3s

Type

Universally configurable to provide:
Thermocouple (THC)
Resistance thermometer (RTD)*
Millivolt
Current
Voltage*
Resistance

*RTD, Resistance and Volts (>2V) inputs are not available on 500V Isolated Analog Inputs

Linearizer functions

Programmable for all inputs including $\sqrt{\quad}$, $x^{3/2}$, $x^{5/2}$
THC types B, E, J, K, R, S, T, L, N, or Pt100
Two 20-breakpoint custom linearizers

Broken sensor detection

Programmable Upscale, Downscale or None
RTD short/open circuit detection
User-programmable fault detection level percentage

Input Ranges and Accuracy

Input Ranges

Input Type	Min. Value	Max. Value	Min. Span	Accuracy (% of reading)
Millivolts	-2000	2000	2.5	±0.1% or ±10µV
Volts	-20	20	0.25	±0.2% or ±2mV
Milliamps	-100	100	0.25	±0.2% or ±2µA
Resistance	0	8000	10	±0.2% or ±0.08Ω

Cold junction compensation

Automatic CJC incorporated as standard
<0.05°C per °C (0.1°F per °F)/change in ambient

Input impedance

Current 10Ω
Voltage 500kΩ
mV & THC >10MΩ

2-Wire transmitter power supply

45mA max. (2 loops), fitted as standard.
Additional loops can be powered from optional TXPSU modules

Standard input module isolation

Channel-to-channel 12V DC dielectric strength
Channel-to-ground 500V DC dielectric strength

500V input module isolation*

Channel-to-channel 500V DC dielectric strength
Channel-to-ground 500V DC dielectric strength

*RTD, Resistance and Volts (>2V) inputs are not available on 500V Isolated Analog Inputs

Common mode rejection

>120dB at 50/60Hz with 300Ω imbalance resistance

Series mode Rejection

>60dB at 50/60Hz

Temperature stability

0.02% of reading/°C (0.01% of reading/°F) or 2µV/°C (1µV/°F)
(whichever is greater)

Long term drift

<0.01% of reading or ±5µV annually

Filtering

Off, 5 to 60s digital filter

Thermocouple and RTD Ranges and Accuracy

THC/RTD Type	°C				°F			
	Min.	Max.	Min. Span	Accuracy	Min.	Max.	Min. Span	Accuracy
Type B	-18	1800	710	±2.0*	0	3272	1278	±3.6*
Type E	-100	900	45	±0.5	-148	1652	81	±0.9
Type J	-100	900	50	±0.5	-148	1652	90	±0.9
Type K	-100	1300	65	±0.5	-148	2372	117	±0.9
Type L	-100	900	50	±0.5	-148	1652	90	±0.9
Type N	-200	1300	90	±0.5	-328	2372	162	±0.9
Type R & S	-18	1700	320	±0.1*	0	3092	576	±1.8*
Type T	-250	300	60	±0.5	-418	572	108	±0.9

* Performance accuracy is not guaranteed below 300°C (572°F) for B, R and S thermocouples

Min. span below zero Type T 70°C (126°F)
Type N 105°C (189°F)

THC standards DIN 43710
IEC 584

RTD***	-200	600	25	±0.5**	-328	1112	45	±0.9**
--------	------	-----	----	--------	------	------	----	--------

** For temperatures between 300 and 600°C (527 and 1112°F) accuracy is ±1.0°C (±1.8°C)

*** RTD, 3-wire platinum, 100Ω per DIN43760 standard (IEC751), with range of 0 to 400Ωs

Electrical

Power supply

85 to 265V 50/60Hz
24V DC ±4V (optional)

Line interruption

<80ms loss, no effect
>80ms loss, auto-reset and restart

Power consumption

40VA max
20W DC (typical)

Electrical safety

EN61010-1, IEC348

Electrical connections

Screw terminals

Advanced Processing Functions

Totalizers

12 independent, with configurable wrap-around, digital/manual reset, stop/start and print

Text messages

24 configurable messages (20-character) assignable to any digital source or alarm function
24 process alarm messages (20-character), 1 per alarm
1 operator message for batch identification (20-character)

Alarms

24 high/low process alarms with programmable level and time hysteresis
4 real-time events with programmable on-time and duration

Math functions

8 user-configurable functions, programmable for standard arithmetic functions or for mass flow, %RH or F-value calculations

Logic functions

10 logic equations, user-defined up to 15 elements per equation (AND, OR, etc.)

...Specification

Physical

Size

326.8mm (12.87 in.) x 147mm (5.78 in.)
x 230mm (9.00 in.) (depth behind panel)

Weight

6kg (13 lbs.) approx.

Panel cut-out

302.8mm (11.92 in.) x 138mm (5.43 in.)

Case material

Stainless steel, painted

Door material

Glass-filled polyarylamide

Window material

Polycarbonate

Keypad material

Polyester

Environmental

Operating limits

5 to 50°C (41 to 122°F),

Electronics <95%RH (non-condensing)

Chart <80%RH (non-condensing)

Storage temperature limits

-20 to 80°C (4 to 176°F)

Dust/Water Protection

Front face IP65 (NEMA3)

Rear of instrument IP20

Electromagnetic compatibility

EN50081-2, EN50082-2

CE marked

Vibration

Designed to meet IEC68

EMC

Emissions and Immunity

Meets requirements of:

EN50081-2

EN50082-2

EN61326 for an industrial environment

CE Mark

Option Modules

3- or 6-Relay output module

Universally assignable to any alarm signal

Relay type changeover Single pole

Voltage 250V AC 30V DC

Current 5A DC

Loading (non-inductive) 150W 1250VA

Note. The total load for all relays within the instrument must not exceed 36A.

Hybrid module

Two isolated analog outputs

Universally assignable to any analog signal or math result

Configurable current range 0 to 20mA

Maximum load 750Ω

Six digital outputs

Universally assignable to any alarm signal or system event, positive or negative logic

True 5V TTL outputs

Six digital inputs 5V TTL or volt-free contact triggered

Analog output isolation 500V from any other input or output

Digital I/O isolation 500V from rest of instrument

2-wire transmitter power supply module

Two isolated 24V outputs (45mA each)

Each output capable of driving 2 loops

RS485 serial communication (Modus) module

EIA communications standard RS485 (2- or 4-wire)

Protocol Modbus RTU (slave)

Baud rate User selectable up to 9600

Isolation 500V from rest of instrument

Memory card port

PCMCIA/SRAM 'credit card' type

Card sizes 64kb, 128kb, 256kb, 512kb, 1Mb, 2Mb, 4Mb

Configuration storage DOS format files

Configuration capacity 32 configurations max.

Overall Dimensions

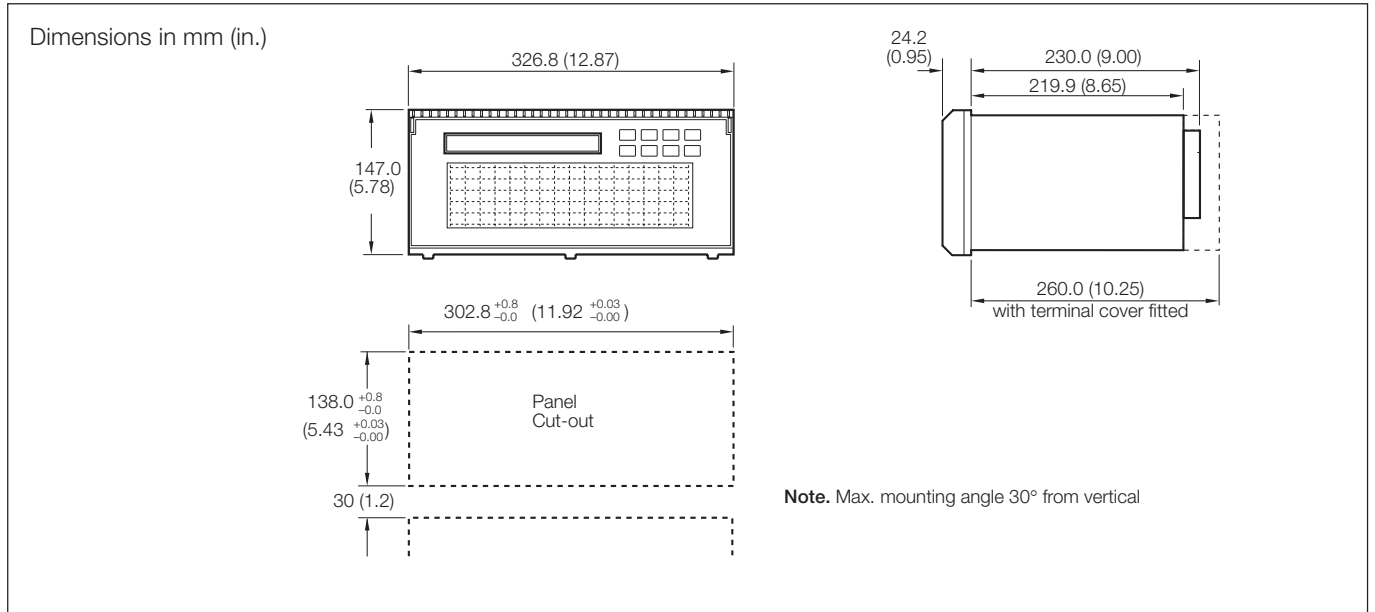

Electrical Connections

Instrument viewed from rear

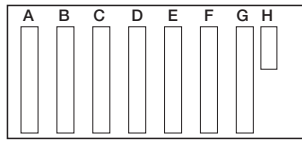

H Power Supply

1	⊗	L	Line	
2	⊗	N	Neutral	AC
3	⊗	E	Earth	
4	⊗	+	+	DC
5	⊗	-	-	
6	⊗			
7	⊗	+24V	+	2-wire Transmitter d.c. Power
8	⊗	0V	-	

A, B, C, D Analog Input Connector

⊗	1	+	Analog I/P 1
⊗	2	-	
⊗	3		3 rd lead RTD
⊗	4	+	Analog I/P 2
⊗	5	-	
⊗	6		3 rd lead RTD
⊗	7	+	Analog I/P 3
⊗	8	-	
⊗	9		3 rd lead RTD
⊗	10	+	Analog I/P 4
⊗	11	-	
⊗	12		3 rd lead RTD
⊗	13	+	Analog I/P 5
⊗	14	-	
⊗	15		3 rd lead RTD
⊗	16	+	Analog I/P 6
⊗	17	-	
⊗	18		3 rd lead RTD
⊗	19		Logic I/P
⊗	20		0V

Analog input 1, 2 and 3 only
for a 3-input module

E, F, G Relay Output

⊗	1	NC	Relay 1
⊗	2	NO	
⊗	3	C	
⊗	4	NC	Relay 2
⊗	5	NO	
⊗	6	C	
⊗	7	NC	Relay 3
⊗	8	NO	
⊗	9	C	
⊗	10	- Spare	
⊗	11	NC	Relay 4
⊗	12	NO	
⊗	13	C	
⊗	14	NC	Relay 5
⊗	15	NO	
⊗	16	C	
⊗	17	NC	Relay 6
⊗	18	NO	
⊗	19	C	
⊗	20		

E, F, G Transmitter DC Power Supply

⊗	1	+	24V
⊗	2	+	
⊗	3	-	
⊗	4	-	24V
⊗	5	- Spare	
⊗	6	- Spare	
⊗	7	+	24V
⊗	8	+	
⊗	9	-	
⊗	10	-	
⊗	11		
⊗	12		
⊗	13		
⊗	14		
⊗	15		
⊗	16		
⊗	17		
⊗	18		
⊗	19		
⊗	20		

E, F, G Hybrid

⊗	1	Dig I/P 1
⊗	2	Dig I/P 2
⊗	3	Dig I/P 3
⊗	4	Dig I/P 4
⊗	5	Dig I/P 5
⊗	6	Dig I/P 6
⊗	7	Common I/P
⊗	8	Common I/P
⊗	9	Dig O/P 1
⊗	10	Dig O/P 2
⊗	11	Dig O/P 3
⊗	12	Dig O/P 4
⊗	13	Dig O/P 5
⊗	14	Dig O/P 6
⊗	15	Common O/P
⊗	16	Common O/P
⊗	17	+ Analog O/P 1
⊗	18	- Analog O/P 1
⊗	19	+ Analog O/P 2
⊗	20	- Analog O/P 2

G RS485 Communications

⊗	1	-	TX 4-wire
⊗	2	-	
⊗	3	+	TX 4-wire
⊗	4	+	
⊗	5	-	Spare
⊗	6	+	TX/RX 2-wire & RX 4-wire
⊗	7	+	
⊗	8	-	TX/RX 2-wire & RX 4-wire
⊗	9	-	
⊗	10	-	Spare
⊗	11	-	Common
⊗	12	-	
⊗	13		
⊗	14		
⊗	15		
⊗	16		
⊗	17		
⊗	18		
⊗	19		
⊗	20		

Note. Refer to instrument code for module positions
Relay 1, 2 and 3 fitted for 3-relay module

Ordering Information

SR250A Advanced Process Recorder	SR250A /	XX	X	/X	X	0	/X	X	X	/X	X	X	XX
Number of Traces and Input Channels													
3		03											
6		06											
9		09											
12		12											
15		15											
18		18											
21		21											
24		24											
Input Dielectric Strength (channel-to-channel)													
12V													
500V *				S									
Build													
Standard				B									
CSA (pending)				C									
UL (pending)				U									
Memory Card Port													
None						0							
PCMCIA						M							
Option Module E													
None								0					
3 relays								3					
6 relays								6					
Digital I/O & analog output								H					
Transmitter power supply unit								T					
Option Module F													
None									0				
3 relays									3				
6 relays									6				
Digital I/O & analog output									H				
Transmitter power supply unit									T				
Options Module G													
None										0			
3 relays										3			
6 relays										6			
Digital I/O & analog output										H			
Modbus serial communications										S			
Transmitter power supply unit										T			
Case Option													
Standard panel mount												1	
Standard panel mount with terminal cover												2	
Chart Type													
Roll chart													1
Power Supply													
85V to 265V AC													2
24V DC													3
Programming/Special Features													
Configured to factory standard													ST
Configured to customer requirements													CM

* 500V Input dielectric strength available only on 6, 12, 18, 24 channel versions

Accessories

Carrying case (part no. PR250/0701)

PC Configurator kit (part no. C100/0700)

Licensing, Trademarks and Copyrights

Modbus™ is a trademark of Modicon, Inc.

Windows™ is a trademark of the Microsoft Corp.

ABB has Sales & Customer Support
expertise in over 100 countries worldwide

www.abb.com

The Company's policy is one of continuous product
improvement and the right is reserved to modify the
information contained herein without notice.

Printed in UK (09.05)

© ABB 2005



ABB Limited

Howard Road, St Neots
Cambridgeshire
PE19 8EU
UK
Tel: +44 (0)1480 475321
Fax: +44 (0)1480 217948

ABB Inc.

125 E. County Line Road
Warminster
PA 18974
USA
Tel: +1 215 674 6000
Fax: +1 215 674 7183