



Trasformatore amperometrico neutro esterno  
 External neutral current transformer  
 Stromwandler für außenliegenden Neutralleiter  
 Transformateur de courant neutre externe  
 Transformador amperométrico neutro exterior

	%In	E1-E2 50-100%	E1-E2 200%	E3 50-100%	E3 200%	E4 50%	E6 50%	E4 fs 100%	E6 fs 100%
		1	-	1	-	1	1	-	-
		-	1	-	1	-	-	1	1
		1	-	-	-	1	-	-	-
		-	-	1	-	-	1	-	-
		-	1	-	-	-	-	1	-
		-	-	-	1	-	-	-	1

**A**

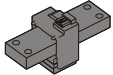
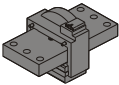
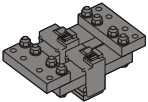
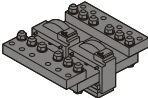
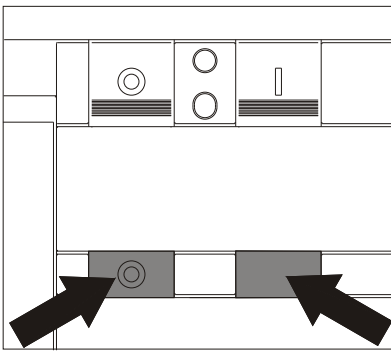

APERTO  
 OPEN  
 AUS-STELLUNG  
 OUVERT  
 ABIERTO

BIANCO  
 WHITE  
 WEISS  
 BLANC  
 BLANCO

**B**

Morsettiera  
 Terminal box  
 Klemmensleiste  
 Bornier  
 Placa de bornes

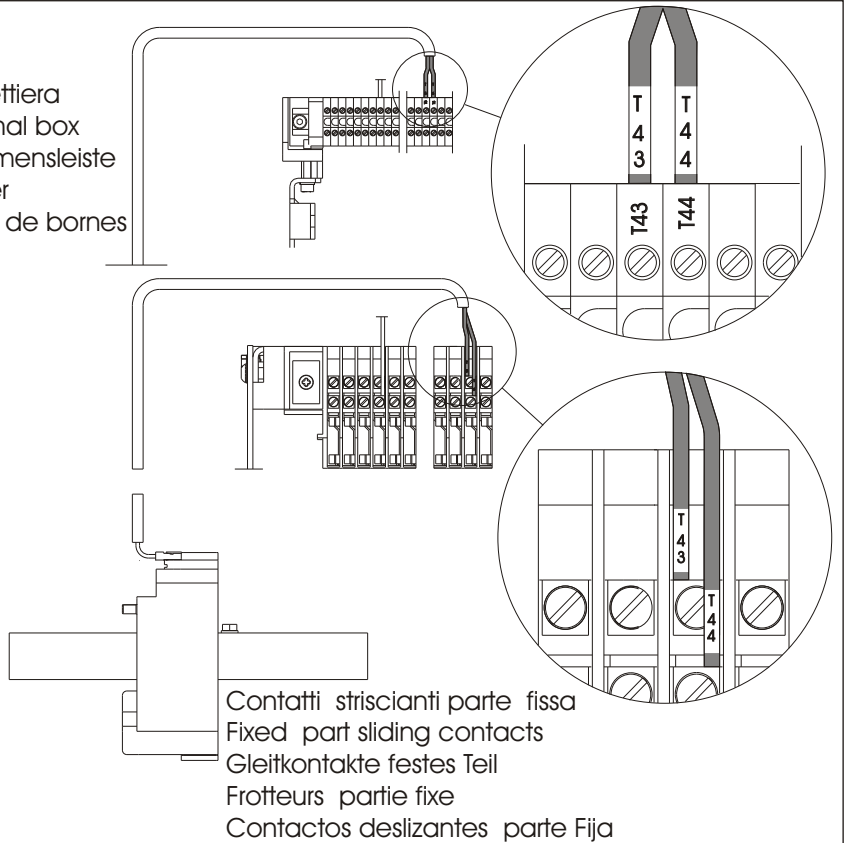

**C**

Terminale inferiore  
 Lower terminal  
 Unterer Anschluß  
 Prise inférieure  
 Terminal inferior

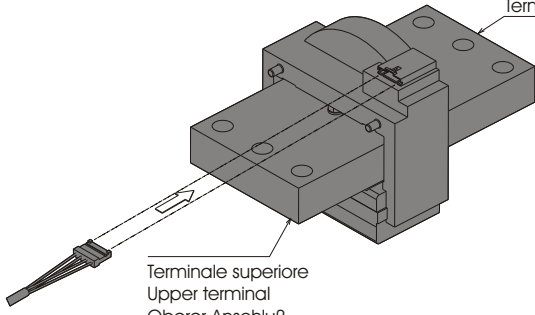

Terminale superiore  
 Upper terminal  
 Oberer Anschluß  
 Prise supérieure  
 Terminal superior

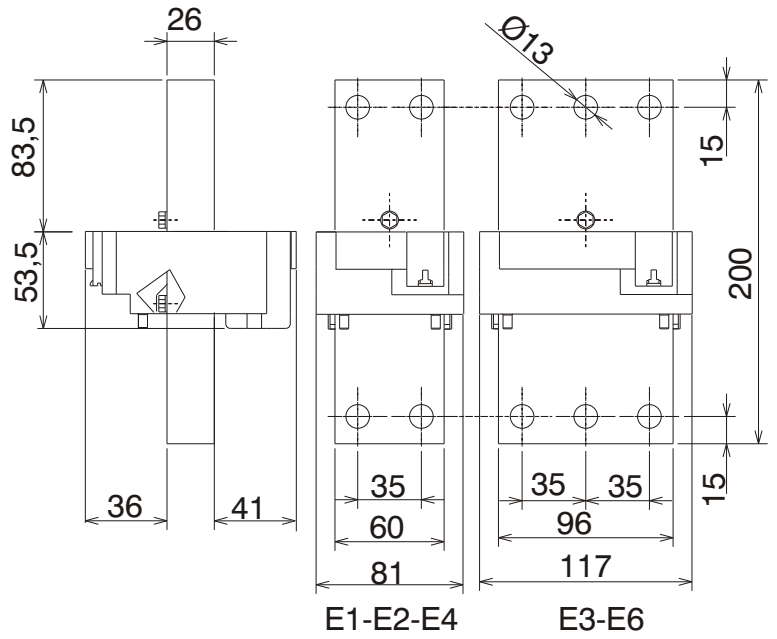
**D**

Terminale inferiore  
 Lower terminal  
 Unterer

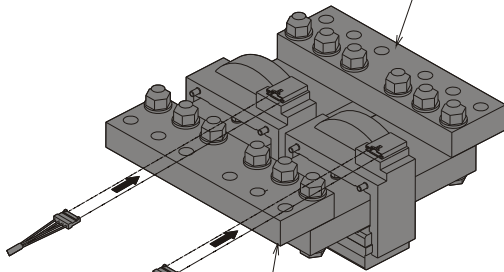

Terminale superiore  
 Upper terminal  
 Oberer Anschluß

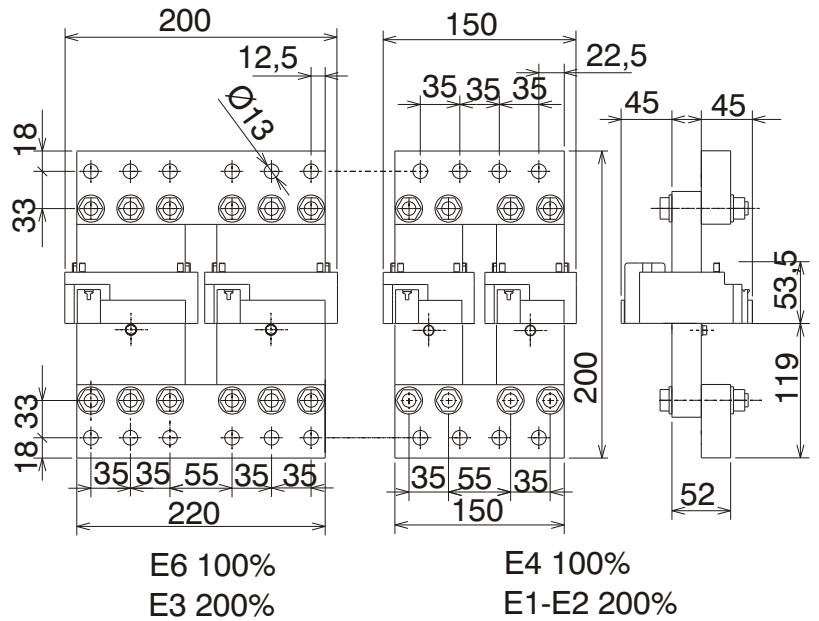

**ABB SACE S.p.A.**

Via Baioni, 35  
24123 Bergamo Italy

Tel.: +39 035 395.111 - Telefax: +39 035 395.306-433

<http://www.abb.com>