

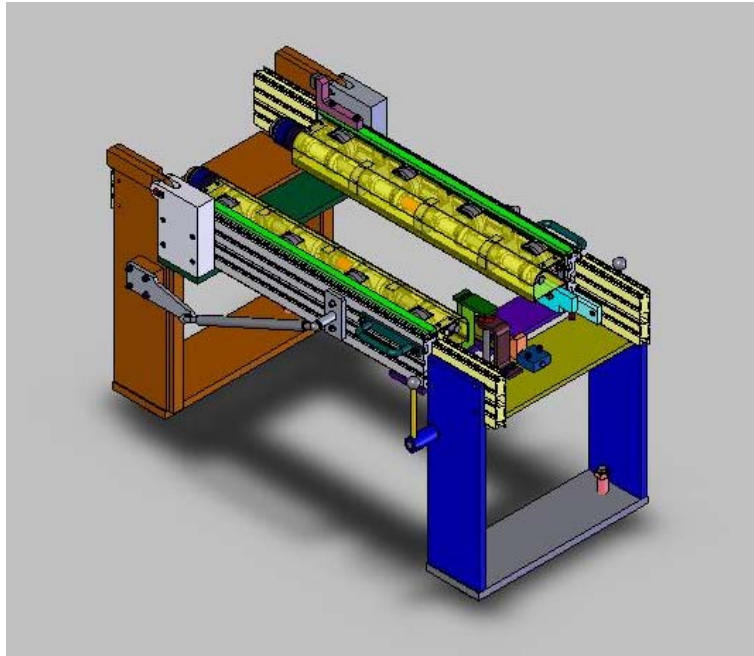

MS-7 800mm Conveyor – Power Liftgate

Main Applications: Palletized Transport



Description:

- Provides access to both sides of transport system

Equipment:

- Average weight distribution: 100 – 700 Kg
- 1 Meter of MS-7 conveyor slave driven through detaching coupler
- Two (2) gas shocks
- Double-sided opening lever
- Locking latch
- Dual leg assembly available in 500mm and 800mm pallet heights
- Required option: Pre-station pallet stop
- Required option: Pre-station pallet switch assembly
- Required option: Anti back-up assembly

Customer Benefits:

- Quick and easy access to both sides of transport allows for rapid response
- 1 Meter standard length allows for easy packaging into system layouts
- Gas shock provides a smooth opening and closing effort without dangerous counterweights

Global Code:

S0700-130-80

Version: A



MS-7 800mm Conveyor – Power Liftgate

Process Parameters

Name	Values	Units	Description
Load	700 (max); n/a (default); 100 (min);	Kg	Transport load capacity of this conveyor
Roller pitch	200 (min); 250 (max); 250 (default);	mm	Pitch of the rollers
Height	500 (min) or 800 (default); n/a (max);	mm	Height of conveyor from machine floor
Standard length	1	meters	Standard length

Design Parameters

Name	Values	Units	Description
Speed	15 (default); 2 (min); 18 (max);	Meters/min	Operating speed limits of this conveyor
Delivery	10 (min); 12 (default); 18 (max);	weeks	Delivery time
Conveyor width	500 (min), 600 or 800 (default); 1000 (max);	mm	Pallet width

Reference Projects:

301152; 301171; 301172; 301174; 301200; 301217; 301216; 301243; 301228; 301229; 301239; 301351; 301359; 301364

ABB Inc.
1250 Brown Road
Auburn Hills, Michigan 48326
T/ 248-393-4600
F/ 248-393-4603

ABB Automation Technologies AB
Powertrain
Omformargatan 18
SE-72137 Västerås
Sweden
T/ +46-21-3600-400
F/ +46-21-3600-450

ABB Engineering Ltd.
31 Industrial Building
Fu Te Dong San Road
Waigaoqiao FTZ, Pudong
Shanghai, P. R. China 200131
T/ +86-21-6105-6666
F/ +86-21-6105-6667

www.abb.com/robotics

ABB Inc.

