



Mounting and installation

The 670 IEDs are 6U high (265.9 mm) and are available in 1/2, 3/4 and 1/1 case sizes for 19" racks. All IEDs fit into a 19" rack with the help of alternative cover plates or with COMBIFLEX relays/cases, of type RHGS6 and RHGS12.

The mounting details are: side by side mounting plates (1) 1MRK 002 420-Z when two relays or a relay and relay rack are mounted together. Mounting brackets for a full 19" (2) 1MRK 002 420-CA. Cover plates with brackets for 19" mounting for 3/4 case size 1MRK 002 420-BA, and for 1/2 case size 1MRK 002 420-BB.

Alternatively the IED can be flush mounted. The IED can be ordererd with optional IP 54 ingress protection.

Test switches and COMBIFLEX auxiliary relays can be mounted in separate relay cases. The RHGS6 and RHGS12 types of cases can be used and bolted together with the IED 670 to fill a relay rack. If the RTXP24 test switch is used, mounting brackets for apparatus bars, ordering No. 1MRK 000 020-BT are required. A suitable test switch with contacts for example for a line protection IED such as REL 670 is selectable when ordering. This allows commissioning and maintenance testing of the complete IED with many functions from one test handle.

Note! The use of test switch RTXP24 NO contact 29-30 to perform software blocking has several advantages and is used during testing of many functions in the same protection IED.

Test is supported by the configuration TEST function block. Switching the IED to test mode will allow blocking and releasing of individual functions separately and also blocking of events to the SA system.

For test system references refer to *Buyers guide* 1MRK 512 001-BEN COM-BITEST. For Dimensions, mechanical design and mounting accessories refer to *Buyers Guides* 1MRK 514 003-BEN and 1MRK 514 004-BEN.

Builder's guide 1MRK 500 079-MEN provides information regarding how to use the IED's in actual SA installations.

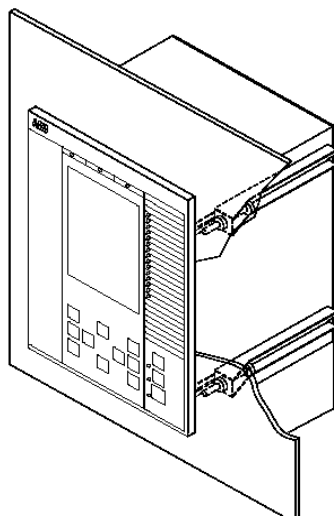

en05000411.vsd

Figure 1: Flush mounting.

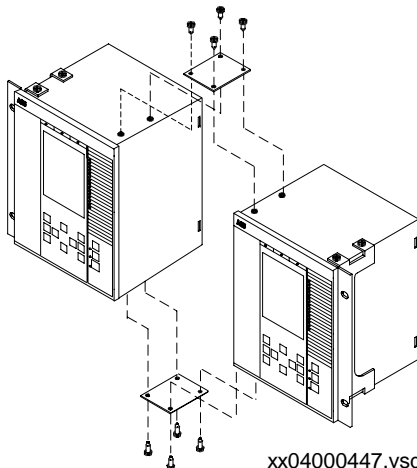

xx04000447.vsd

Figure 2: Mounting plates for side-by-side and the mounting brackets and flush mounting kit.

Note! Ensure that the case is properly earthed.

Connectors and inputs

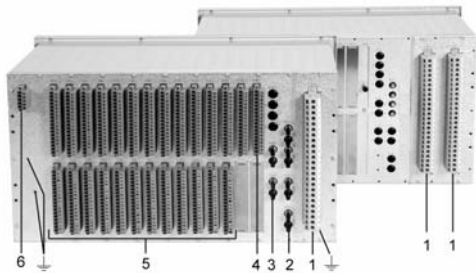

Figure 3: Module positions and grounding screws.

Note! Ensure that the case is grounded with the grounding screw.

1. Transformer Module (TRM).
2. Analog Digital Module (ADM) with LDCM and OEM boards mounted.
3. Numerical Processing Module (NUM) with SLM/LDCM.
4. Milliampere Input Module (MIM).
5. Binary Inputs and Outputs (BIM, BOM etc.).
6. Power supply module (PSM).

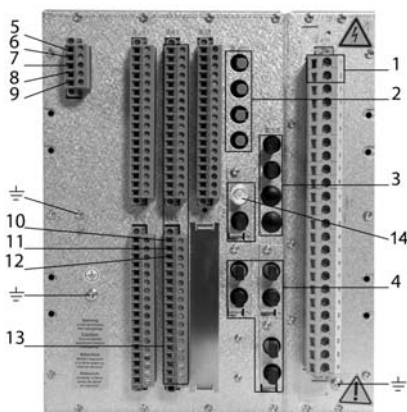

Figure 4: Connections.

1. X401 Two connectors per CT or VT.
2. X301 Optical ports from SLM mounted on NUM.
3. X311 Optical ports from OEM mounted on ADM.
4. X303-323 Optical connectors from LDCM or RS485 mounted on ADM and NUM.
5. X11:1 Ready.
6. X11:2 + Supply (IRF).
7. X11:3 Fail, Binary output (IRF).
8. X11:4 PSM + connector for DC supply.
9. X11:5 PSM - connector for DC supply.
10. Binary output no.13 on a BOM.
11. DC source for Binary outputs 13 and 14 on a BOM.
12. Binary output no.14 on a BOM.
13. X41, X42 BIM, BOM or IOM.
14. X302 IRIG-B

The rear connectors and rear side layout of the Intelligent Electronic Device (IED) are illustrated in figures 3 and 4.

Viewed from right to left, in figure 3, the connectors are:

1. The connector for the analog inputs of the TRM2 (X411) and TRM1 (X401): The TRM cards are factory equipped with a fixed number of current (6-12) and voltage (3-6) inputs. Make sure the delivered configuration matches the order. The use of analog inputs is defined in the configuration of the IED where each input is tied to a selected function/s.

2. The optional communication board for communication between IEDs or to remote line end is available on ports X312, X313, X302 and X303 as ordered. See figure 4 for details.

3. Communication interfaces for LON, IEC 61850-8-1, SPA/IEC 870-5-103 or DNP according to included options. One or two optical ethernet ports (X311) exist for communication to substation control systems and substation monitoring systems. Two optical ports (X301) for LON, SPA or IEC 870-5-103 communication can be included. LON plus any of the other protocols can be included. See figure 4 for details.

4. The Milliampere Input Module (MIM) is used to interface transducer signals in the 0-20 mA range such as temperature and pressure signals from transducers.

5. The IO board connectors for IOM, BIM or BOM as ordered. Starting with slot 3 (Connectors X31, X32) seen from the rear left side they are equipped as ordered. Check the ordering document. Binary inputs have auxiliary voltage levels as ordered and are designed to be safe against capacitive discharges and bridge initial contact resistance in external contact. See figure 4 for details.

6. The Power Supply Module (PSM) provides the boards with power. Depending on the PSM ordered, the rated input voltage range is 24-60 VDC or 90-250 VDC with a tolerance of 20%. See figure 4 for details.

Each connection terminal or port on the rear side of the IED is numbered. The numbers are stamped into the rear panel above each opening. Viewed from the rear, the lowest numbers are to the left and increase to the right. All numbers begin with an X followed by two or three digits. Analog inputs can be ordered with ring lug connectors as an alternative. The analog inputs are dimensioned for conductor cross section areas of up to 6 mm² and the binary inputs and outputs plus the DC supply are dimensioned for up to 2 x 1.5 mm² conductors. Refer to the *Installation and commissioning manual for mounting instructions*. The torque used to tighten connector screws is 1.0 Nm for analog and 0.4 Nm for binary connections.

The casing, each TRM and the PSM have their own earth connections.

Details regarding hardware modules, refer to the *Technical reference manual* which includes diagrams (schematics) of the electrical connections to the IED 670.

The Human Machine Interface



Small size HMI Medium size HMI

The IED 670 products can be ordered with a small or medium HMI module. Both have a LED panel and a serial communication port on the front panel. The Parameter Setting Tool in PCM 600 toolbox installed on a PC is used to set parameters via the serial port. The PC cable to the HMI from the PC shall be a crossed Ethernet cable with RJ45 connectors. If it is connected via a hub a standard Ethernet cable is used. The Medium HMI has a 150x180 mm Graphic display where single line presentation and control of the IED can be shown in addition to the setting information.

The following keys are provided to navigate the menus:

- **C** is used to cancel or clear
- **E** is used to confirm or enter
- **L/R** is used to set local or remote control
- **Menu** alternates between the menu screen and graphic mode
- **Reset** activates the reset screen
- **Help** activates the help screen
- **I** closes a disconnector or breaker
- **O** opens a disconnector or breaker
- The arrow keys are used to navigate between different screens and data

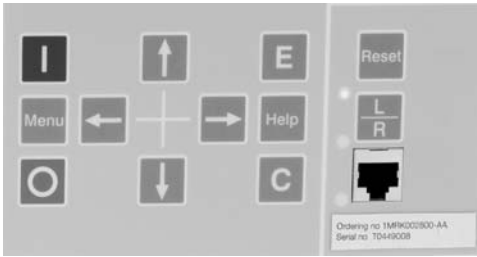

To change a setting, select an item in the menu structure and change it using the up and down keys on the HMI. After selecting parameter values move up through the menu system by repeatedly pushing the left arrow key until a dialog box appears where changes can be confirmed or cancelled.

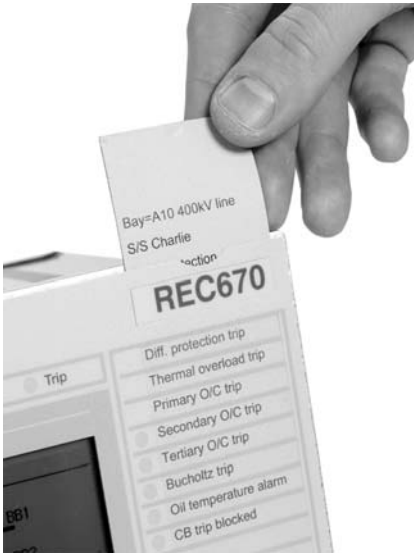

The LEDs on the front panel of the IED are configured with the Signal Matrix Tool and are activated by various events, such as Distance protection trip, Phase selection L1, L2 and L3 and Auto Reclose. The LEDs are labelled according to the configuration chosen. The label is printed and inserted manually from the top, see picture. The labels for each LED can include a maximum of 18 characters in Arial 16 font. These 15 LEDs are alarm indicators and are colored red (1-6) and yellow (7-15). When active they will show flashing or steady light. Use the Reset button to reset the LEDs. Above the LCD there is a green (depends on settings), a yellow (start) and a red (trip) LED. These are activated by general start and trip operations. The Trip logic function block (TRM) must be used and set ON to activate the red LED.

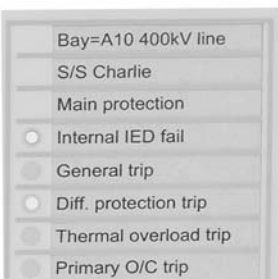

Figure 5: LEDs

On the medium HMI display, the single line diagram can be presented and shows apparatuses that can be controlled locally using the control buttons.

To safeguard the interests of our customers, both the IED 670 and the tools that are accessing the IED 670 are protected, subject of authorization handling. The concept of authorization, as it is implemented in the IED 670 and the associated tools is based on the following facts:

- There are two types of points of access to the IED 670:
 1. local, through the local HMI
 2. remote, through the communication ports
- There are different levels (or types) of users that can access or operate different areas of the IED and tools functionality; the pre-defined user types are defined as follows:

User type	Access rights
Guest	Read only
SuperUser	Full access
SPAGuest	Read only + control
SystemOperator	Control from LHMI, no bypass
ProtectionEngineer	All settings
DesignEngineer	Application Configuration (including SMT, GDE and CMT)
UserAdministration	User and Password Administration for the IED

The IED users can be created, deleted and edited **only** with the User Management Tool (UMT) within PCM 600. The user can only **LogOn** or **LogOff** on the LHMI of the IED, there are no users, groups or functionalities that can be defined on the IED LHMI.

The display time out is set to 60 minutes at delivery. At delivery the default user is the SuperUser. No LogOn is required to operate the IED until a user has been created with the UMT. See *Application manual* for more details.

The Help screen

The help screen is activated by pressing the Help key on the front panel of the IED. It includes the submenu listed below:

- General operation

The General operation submenu provides information about the IED keypad.

The **O** and **I** keys are used to open (OFF) and close (ON) breakers and disconnectors when using the Single Line Diagram (SLD) in direct control situations.

Communication with the IED 670

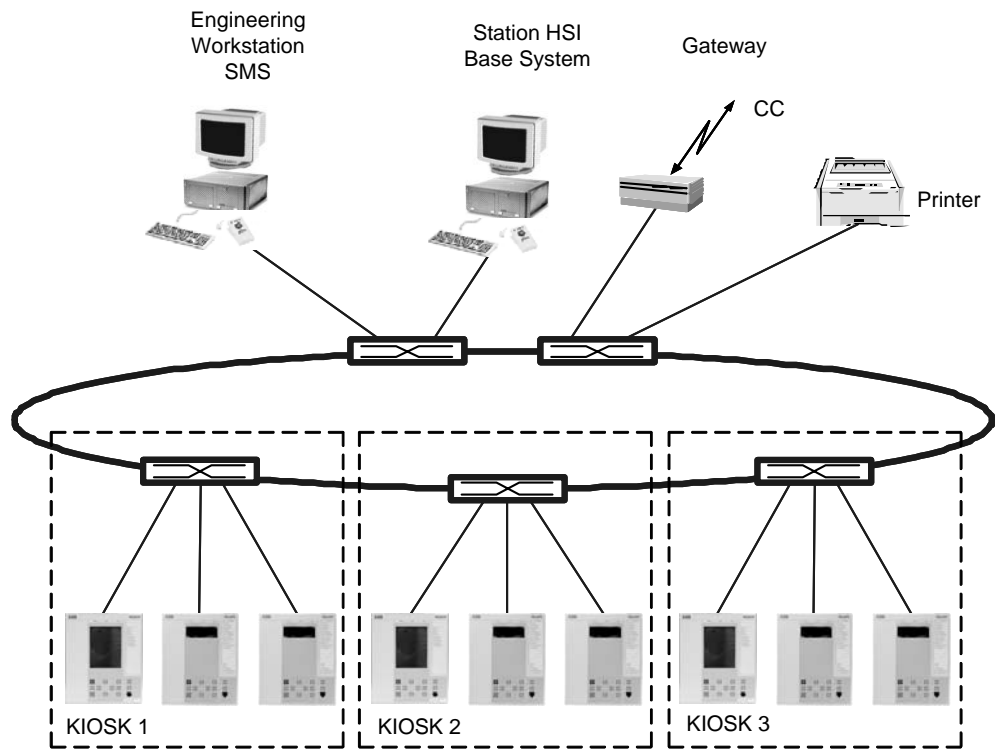

en06000195.vsd

IED 670 IEDs are designed to be part of a station control system with communication gateways to a control centre. A typical system structure is illustrated above. The following should be noted:

1. The following protocols are available in the current release of the IED 670: IEC61850, IEC60870-5-103, SPA, LON, DNP 3.0, IEC61850 uses Ethernet and TCP/IP while IEC60870-5-103, SPA, LON are serial protocols; DNP 3.0 can use both Ethernet and serial ports.
2. There are several ways to synchronize the internal clock of an IED 670:
 - via an IRIG-B input, from a station clock; the clock can provide local time of the year in this format. The "B" in IRIG-B states that 100 bits per second are transmitted, and the message is sent every second. After IRIG-B there is a number of figures stating if and how the signals is modulated and the information is transmitted. To receive IRIG-B there are two connectors in the IRIG-B module, one galvanic BNC connector and one optical ST connector. IRIG-B 12x messages can be supplied via the galvanic interface, and IRIG-B 00x can be supplied via either the galvanic interface or the optical interface.
 - via GPS satellite clock, e.g. the Meinberg LANTIME which has been verified for Network Time Protocol (NTP) format. The clock is connected to the station bus communication switch. Other clocks can also be used but please check back if they were verified by ABB.
 - the same GPS satellite clock can synchronize an IED via a binary input (B.I), with the disadvantage of using copper cables over the whole substation.
 - The IED can also be synchronized from another IED 670 equipped with a GPS module, acting like a SNTP server.
3. The Station HMI can be any type of HMI managing the IEC 61850-8-1 or the LON protocol if this is selected. The ABB Micro SCADA is verified for high performance, event handling, and analog values, even in large stations.
4. Peer-to-Peer communication is made possible using both IEC 61850-8-1 with GOOSE and LON. In the IED 670 IED the incoming signals (LON) are set up with a Command block (Cmd) and the outgoing signals with an Event block (Ev) when the unit is configured. Horizontal communication is set up with a communication tool for IEC61850 or LON.
5. The communication Gateway for the control centre provides protocol conversion to the required SCADA protocol, which today is usually DNP3.0, IEC870-5-101 or IEC870-5-104. The Gateway provides event grouping and adapted dead bands to minimize traffic on the link to the control centre.

Configuring the IED 670 functions

Start-up

The PCM 600 toolbox is used to configure protection IEDs in the IED 670 series. The tool includes a project manager and tools for all necessary tasks. Install the PCM 600 in your computer first and then install the IED connectivity packages. Start the PCM 600 and build a new project.

System requirements:

- Operating system: Windows 2000 SP4 / XP SP2

Hardware requirements, minimum/recommended:

- Physical RAM memory: 512 MB / 1 GB
- Free hard disk space: 500 MB / 1 GB
- Processor: Pentium 900 MHz / Pentium 2 GHz

To start installation of PCM 600 insert the installation CD into the CD-drive. If installation doesn't start automatically, execute setup.exe in the root folder on the installation CD. When the installation begins select the software that you prefer to install and follow the instructions to complete the installation.

Note! If you don't have Microsoft SQL Server Desktop Engine already installed this will be installed when installing PCM 600. Installation of PCM 600 can only be made as a standalone installation.

After the installation has completed, start Connectivity Package Manager from desktop to activate installed Connectivity Packages for PCM 600.

Prerequisites:

- To operate with PCM 600, there must be at least one communication Connectivity Package and one IED Connectivity Package installed and selected to be used with PCM 600. The IED Connectivity Packages are delivered with the IED's.

Start the PCM 600 from the desktop and build a new project. For the new project your system structure with stations, voltage levels, bays and IEDs is built-up in the plant structure. Right click your mouse or locate the plant structure components in the menu.

Setting up your communication

To communicate with the IED the following set-up is required under the communication structure and/or properties for an IED.

- The TCP/IP address on the PC must be set. If your computer setting is DHCP the connection will not work. Set-up your PC manually with values close to the values set in the HMI tree, under General settings/Communication/Network Interface/Ethernet. **Note!** You need to have administrator rights to start up the communication.
- The IP address is set under communication structure (right click the plant structure tab) Select the IED and set the IP address under properties as shown in figure 6.
- Set the SPA address for the IED under the communication structure. Open the IED and the LDO and set the address to 30. See figure 8.

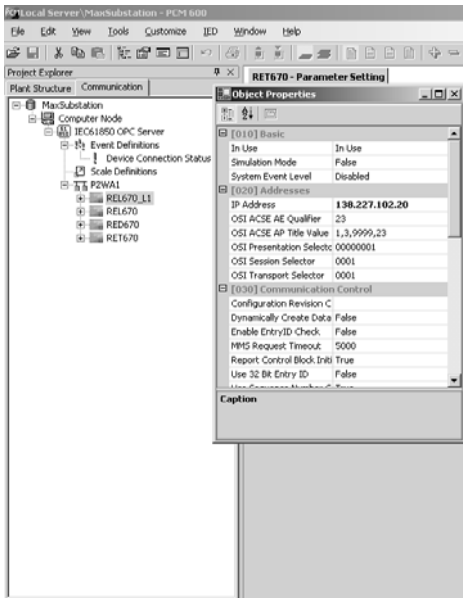

Figure 6: Setting IP.

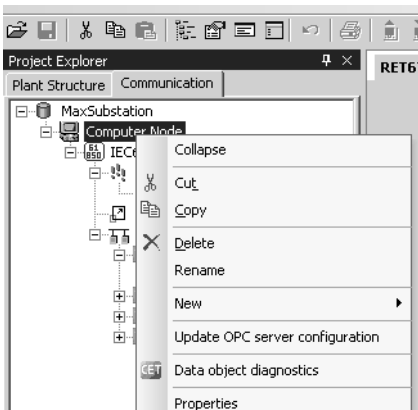

Figure 7: OPC Server configuration.

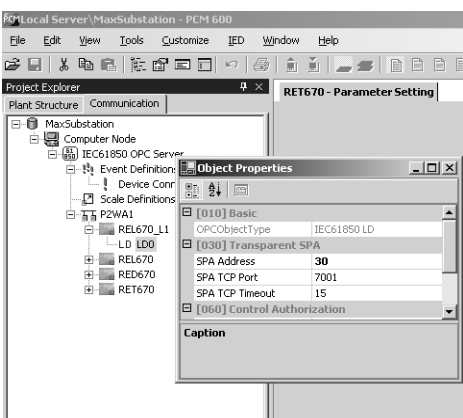

Figure 8: SPA Address.

- The OPC server name, for IEC 61850-8-1 shall be:
ABB.PCM.IEC61850_OPC_DA_Server.Instance[1].
This is set under: Communication structure/IEC61850/OPCserver/Properties.

Update the OPC server configuration under the communication structure as shown in figure 7.

Connect to the IED with a crossed Ethernet cable, or straight if connected through a hub. You can ping the IEDs IP address in command mode to verify contact before starting to use the PCM 600 toolbox.

Configuration

Configure the IED with the CAP 531 Application configuration tool. The default password is **abb**. Right click on IED and select Application Configuration.

The PCM 600 toolbox can be used to upload the ordered default configuration from the IED and then change it to suit the needs of the application, however the selected configuration will normally be sufficient for any application once the binary input/outputs and analog inputs have been defined in the signal matrix tool (described below).

If the configuration needs to be changed the existing configuration can be uploaded or the version in the CAP 531 template library used. The template library contains basic frameworks on which to build a complete configuration. In CAP 531 you can add worksheets and your own logic such as automatic switching logic etc. as required. It is advisable to always upload the IED options as a first step. This harmonizes available functions in the tool with the one in your IED. You can insert new worksheets under Edit, increase worksheet size or add functions on existing worksheets.

Insert your new functions from the function library into the selected locations. Click the inputs or outputs and type “v” to give variable names to a connection. Connect to the other end with the same signal name, alternatively draw the connection with the connector tool. Outputs may go to several function blocks but inputs may only be connected to one so an OR gate might be required. Signals to other sheets shall preferably be drawn to the edge of the sheet where there is a red line. This ensures that signal cross-references will be shown at printout.

Open inputs are not allowed, connect them to FALSE (Off) or in some cases to TRUE (On).

When you are ready, save and compile. Errors can be double-clicked to find the source of the error signal. This allows the user to quickly correct any errors.

Note!

Signals from remote end via the LDCM communication card are configured with the signal matrix tool for connection to virtual analog input function blocks.

The Signal Matrix tool is also used to configure what is shown by the 15 LED's. Signals to the LED's can be selected from virtual inputs or outputs so signals required to be shown must first be configured to the virtual IO blocks.

Download the complete configuration with OnLine/Download or click the menu symbol. Do not interrupt during a download session. Downloading should take approximately 2 minutes.

Once the download is completed testing can begin and the advantages of the debug tool become apparent. Activate the worksheet and select OnLine/Debug with the IED connected to the PC. This provides access to all signal status, red is active, blue is inactive and green is for floating numbers such as counters, phase selection etc. Test your IED to verify that the configuration is correct.

***Note!** The configuration connects signals to virtual IO which needs to be tied to the physical IO with the signal matrix tool described below. These connections must be made before the testing is started.*

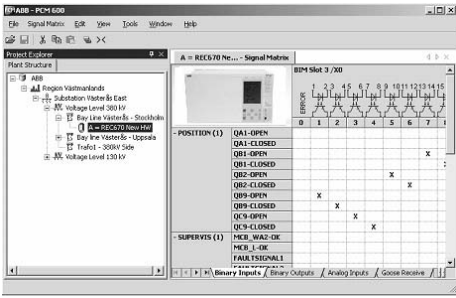

Figure 9: The Signal Matrix Tool

Signal Matrix Tool (SMT)

The SMT connects the virtual IO to the physical IO. This offers high flexibility without the need to adjust the configuration. When a configuration has been completed with the Application configuration tool CAP 531, the Signal Matrix tool can be opened. This is done from the PCM 600 menu that appears when the right mouse button is clicked on the IED symbol in the system project structure. Changes made in the IED since the last compilation are shown at initiation.

Connect your IO. The configuration has an appropriately chosen default IO arrangement but the tripping signals are connected to the physical IO supplied as basic supply. Alarm signals and the like must be configured per application.

Analog signals can be connected to separate CT cores, VT fuses and so on but different protection functions may also be connected to the same analog channels according to user preferences and the availability of analog channels.

Download the signal matrix. Changes such as reconfiguration of the analog supply will require a full restart of the IED. Simple output signal changes on the other hand can be executed quickly. Proceed with testing, or if settings first need to be adjusted refer to the next section before starting tests.

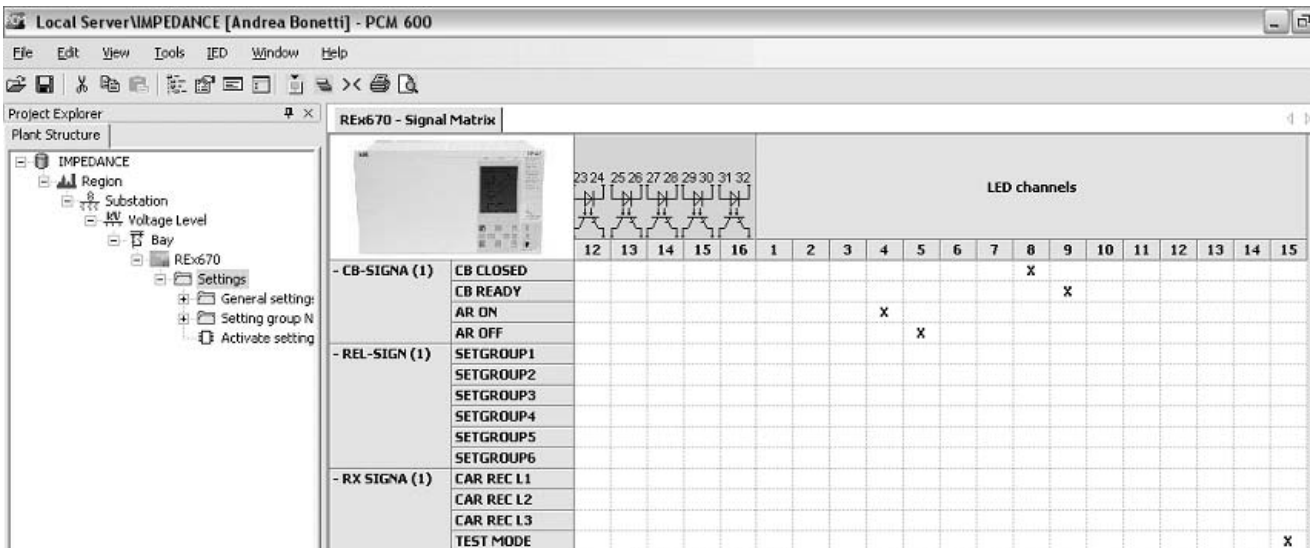

Setting of IED 670 functions

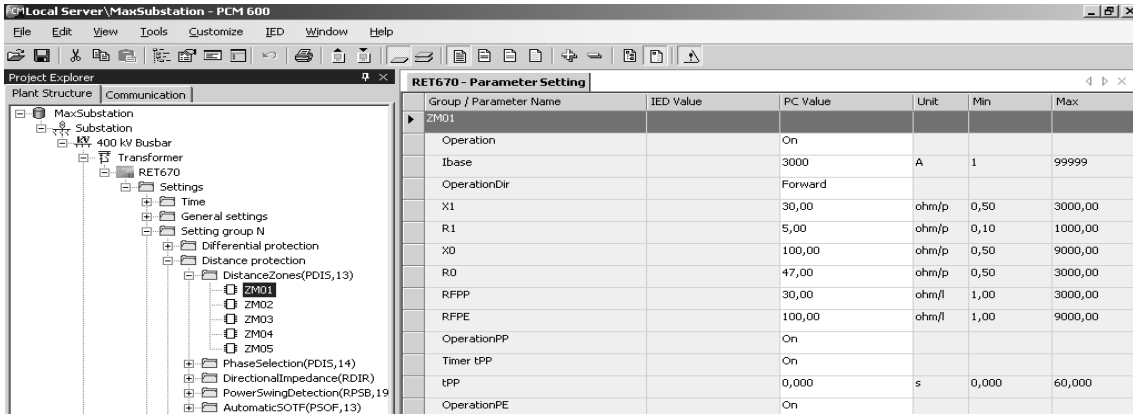

Note!

IED 670 is set in primary values for all functions!

Note!

In a commissioned plant it is not permitted to change settings to values other than those in another pre-tested setting group. The Block-Set function block shall be activated after commissioning to prevent any change of Settings, Configuration, Signal matrix or graphical HMI.

The Parameter Setting tool is accessible in another part of the PCM 600 structure, open it by right clicking on the IED and select the setting tool. The Parameter setting tool will show the functions configured and compiled in the CAP 531 tool. Navigate through the functions menu and set the General settings and those for the setting groups utilized. Note that the number of the setting group used is settable on the number of setting groups function block. This avoids switching to a setting group with default setting values that is not used. The changed parameters will be in bold text. Copy and paste are supported for your convenience.

Changed General setting parameters require a full restart of the IED and are not generally changed once a plant has been commissioned. Setting group changes take place immediately. There are Normal user and Advanced user settings. Advanced user settings are seldom changed settings such as user defined setting characteristics, function times and settings. You can simply toggle between the two on the tool menu bar if something needs to be checked. Download the settings to the IED by clicking the download symbol on the menu. Individual parameters, the complete IED structure, General settings and Setting groups can be downloaded individually or according to preferences. It is advisable to download individual functions and read back the values for verification.

Disturbance recorder handling

The IED 670 includes a Disturbance recorder (DR) with 40 analog and 96 digital channels. It has a default configuration and signals have been given names which will show-up on the records. The binary (and also analog) signals can, by setting, be made visible or hidden and to trigger a disturbance recording. Select according to your preference for each of the 96 binary signals. If you need to connect other signals or more signals (or change names) you need to use the CAP 531 application configuration tool. Disturbance records are stored in COMTRADE format which can be used for evaluation with most tools.

Disturbance records are uploaded from the PCM 600 toolbox with a scheduler or manually. Open the Disturbance recorder tool. Right click on the lower part where the IED disturbances are shown and upload the list. Mark the disturbances you want to move to the PC and upload, you will find this option by right clicking the mouse.

Uploaded disturbances, refreshed if required, can be shown either in a report using the default template or other templates created with the available wizard. The short report will be in pdf format and can be arranged to be automatically e-mailed, to defined addresses. There is also an option that shows the disturbance in a viewer such as WinEve. Select this option by right clicking on the selected disturbance and evaluate in detail the cause of the recorded disturbance.



Figure 10: Disturbance handler

Application functions

The IEDs are very flexible and may include a wide range of protection and control functions. Many of these are included as basic in the “ready-to-use” IED. The IED is delivered with a basic configuration that includes default parameter settings. This simplifies the initial start-up of the IED. In the IED 670 series the following examples are preconfigured default functions, included and set to typical values: Id > (PDIF, 87), Z< (PDIS, 21), Zpsb (RPSB, 78), O->I (RREC, 79), 3U< (PTUV, 27). These are set to ON. The default setting for backup functions is OFF.

The configuration is available under the Basic template for the IED or can be uploaded into the structure with the configuration tool. By default, a number of signals are associated with the disturbance report and will show up on the display and be recorded as disturbance records. It is always possible to return to the default configuration if problems with a specific configuration arise. IO configurations are order specific and are therefore not included in the default configuration. To activate inputs and outputs, configure them with the Signal Matrix tool. For help, refer to the configuration tool section in this document.

Each protection function has a function block with both analog and binary inputs and outputs. The function blocks are described in detail in the Technical reference manual. The analog inputs are connected by default to a pre-processing analog block in the configuration and a cross reference table is generated in the parameter setting tool (PST) which is part of the PCM 600. Ensure that the analog signals connected to the function blocks are checked so that the correct inputs are fed with analog signals when testing. Binary signals are connected with the configuration tool.

A number of logical elements are available giving the user enough flexibility to create his own applications. OR gates are useful as several signals cannot be connected to one input. An OR gate then allows the user to tie any combination to a single binary output or functional input. OR gates also allow a combination of signals such as the creation of alarm groups which are connected to IO ports. Consider also the debug possibilities where the status can be seen on-line since this can be very useful when testing is performed. Each ordered function can be included in the configuration with the configuration tool, but can also be left in the library for future use. How to test the functions is described in the Installation and commissioning manual.

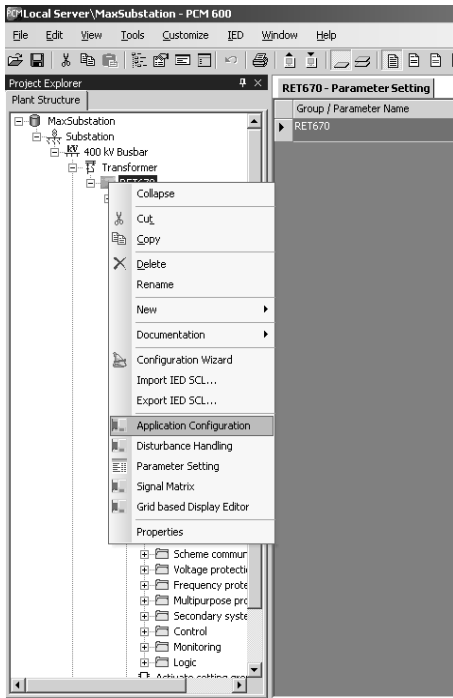

Figure 11: Application configuration.

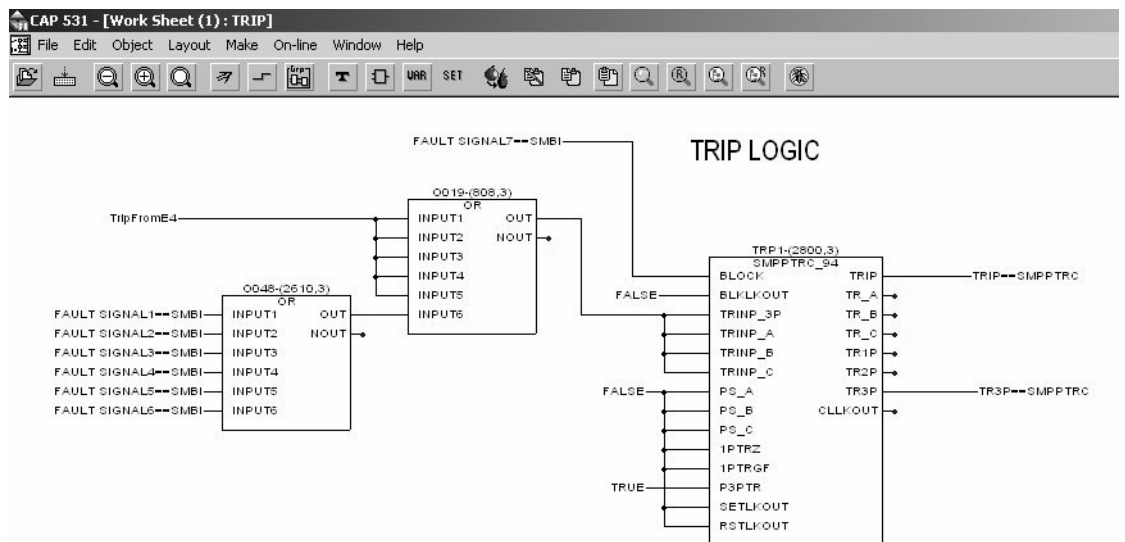

Figure 1: Logic diagram.

Fault finding

Record #	Date	Time
Record #10	2004-12-16	14:22:20.511
Record #09	2004-12-16	12:18:20.511
Record #08	2004-12-16	12:17:59.511
Record #07	2004-12-15	12:17:54.511
Record #06	2004-12-14	08:02:33.289
Record #05	2004-12-14	08:02:27.808
Record #04	2004-12-13	23:17:54.511
Record #03	2004-12-12	23:17:53.511
Record #02	2004-12-11	23:17:54.511
Record #01	2004-12-11	23:17:53.511

Manual Trig

2004-12-17 08:37 North Connection

Figure 12: Disturbance records list viewed on the HMI

A flashing green LED indicates an internal fault. Check the IED Status menu to find the problem. A flashing yellow LED indicates that the IED is in Test mode. Navigate to the Test menu and switch the Operation - Off. When the yellow LED is on and shines steadily a protection function has started and a disturbance report has been generated

When a red LED shines – the protection has operated and caused a trip. Reset with the C button. If this does not work the fault is still present, or the lock-out is activated and locked. If so reset the lock-out.

The IED Report self supervision display has the following displays. Self monitoring – CPU error: Indicates a CPU problem but could for example also be a remote communication problem if the LDCM module is included.

AD error: Indicates a problem on the dataflow or values from the A/D converter

IO error: Indicates an error in communication with an IO or a fault in the IO

RTC clock: Indicates a fault in the Real Time Clock.

Time synchronization error: Error of the time synchronization, mostly caused by time triggering signals not arriving within the time required by the IED. This can be caused by a lost connection, a clock failure, or delayed signals caused by software handling. In the latter case the signal will normally disappear automatically.

Application problems: The function does not trip or show-up on the HMI.

Note! First check that the function is set to ON and that it is not blocked, or in test mode.

Verify the measurement by checking Test/Function status/..... If a value is shown the function is in operation. If so, check the connection of the function to Trip function TRP, to Disturbance report function DRB and check that the setting of the Channels in DRB are correct i.e. Settings/Monitoring/DR/. Operation = On gives trig operation. LED = On gives red LED light at activation of channel. These settings are necessary to show the operation of the function operation on the HMI. If the value for a protection function is not shown in the Service report the reason can be that it does not exist, the function used is incorrect e.g. the incorrect library was used in CAP 531, the analog values are from the wrong channel. Check that it is not connected to the other TRM module. TRM1 is to the right and TRM2 to the left seen from the rear. If the Signal Matrix Tool has been used to configure connections make sure hardware changes are also updated in the SMT.

Related documents

Documents related to RED 670

Operator's manual	1MRK 505 184-UEN
Installation and commissioning manual	1MRK 505 185-UEN
Technical reference manual	1MRK 505 183-UEN
Application manual	1MRK 505 186-UEN
Buyer's guide	1MRK 505 187-BEN

Documents related to REL 670

Operator's manual	1MRK 505 276-UEN
Installation and commissioning manual	1MRK 506 277-UEN
Technical reference manual	1MRK 506 275-UEN
Application manual	1MRK 505 278-UEN
Buyer's guide	1MRK 506 279-BEN

Documents related to REC 670

Operator's manual	1MRK 511 188-UEN
Installation and commissioning manual	1MRK 511 189-UEN
Technical reference manual	1MRK 511 187-UEN
Application manual	1MRK 511 190-UEN
Buyer's guide	1MRK 511 191-BEN

Documents related to RET 670

Operator's manual	1MRK 504 087-UEN
Installation and commissioning manual	1MRK 504 088-UEN
Technical reference manual	1MRK 504 086-UEN
Application manual	1MRK 504 089-UEN
Buyer's guide	1MRK 504 090-BEN

Documents related to REG 670

Operator's manual	1MRK 502 014-UEN
Installation and commissioning manual	1MRK 502 015-UEN
Technical reference manual	1MRK 502 013-UEN
Application manual	1MRK 502 016-UEN
Buyer's guide	1MRK 502 017-BEN

Connection and Installation components	1MRK 013 003-BEN
Test system, COMBITEST	1MRK 512 001-BEN
PCM600, Protection and Control IED Manager	1MRS755552
Builder's Guide	1MRK 500 079-MEN



ABB AB

Substation Automation Products
SE-721 59 Västerås
Sweden

Phone: +46 (0) 21 34 20 00

Facsimile: +46 (0) 21 14 69 18

www.abb.com/substationautomation

If you require further assistance, contact your local ABB support or ABB support line.
Tel: +46 21 342500, e-mail: sa-t.supportline@se.abb.com, fax +46 21 146918,